



Fingerprints of brain cognitive activity

Włodzisław Duch

Neurocognitive Laboratory,
Center for Modern Interdisciplinary Technologies,
Dept. of Informatics, Faculty of Physics, Astronomy & Informatics,
Nicolaus Copernicus University

Google: W. Duch

ICAISC 2018, 3-7 June, Zakopane

IEEE MILESTONE IN ELECTRICAL ENGINEERING
AND COMPUTING

First Breaking of Enigma Code
by the Team of the Polish Cipher Bureau, 1932-1939

Polish Cipher Bureau mathematicians Marian Rejewski, Jerzy Różycki and Henryk Zygalski broke the German Enigma cipher machine codes. Working with engineers from the AVA Radio Manufacturing Company, they built the 'bomba' - the first cryptanalytic machine to break Enigma codes. Their work was a foundation of British code breaking efforts which, with later American assistance, helped to end World War II.

August 2014



Odznaczenie IEEE - "Kamień milowy" w rozwoju
inżynierii elektrycznej i obliczeniowej

Złamanie po raz pierwszy kodów Enigmy przez zespół
matematyków z polskiego Biura Szyfrów w latach 1932-1939

Polscy matematycy Marian Rejewski, Jerzy Różycki i Henryk Zygalski z krajowego Biura Szyfrów złamali kody maszyny szyfrującej Enigma. Pracując razem z inżynierami fabryki AVA w Warszawie zbudowali „bombę” - pierwszą maszynę deszyfrującą kody Enigmy. Ich osiągnięcia były podstawą do dalszych prac Brytyjczyków nad deszyfracją, które w okresie późniejszym z pomocą Amerykanów, przyczyniły się do zakończenia II-giej Wojny Światowej.

Sierpień 2014r



On the threshold of a dream ...

How can we find fingerprints of specific activity of brain structures (regions, networks)?

- AI and abstract models of mind/brain.
- Brain \Leftrightarrow Mind relations.
- Brain networks. Space for neurodynamics.
- Fingerprints of Mental Activity.
- Dynamic functional brain networks.
- Neurocognitive technologies.

Optimization of brain processes?

Duch W, *Neurocognitive Informatics Manifesto*. In: Series of Information and Management Sciences, California Polytechnic State Univ., pp. 264-282.

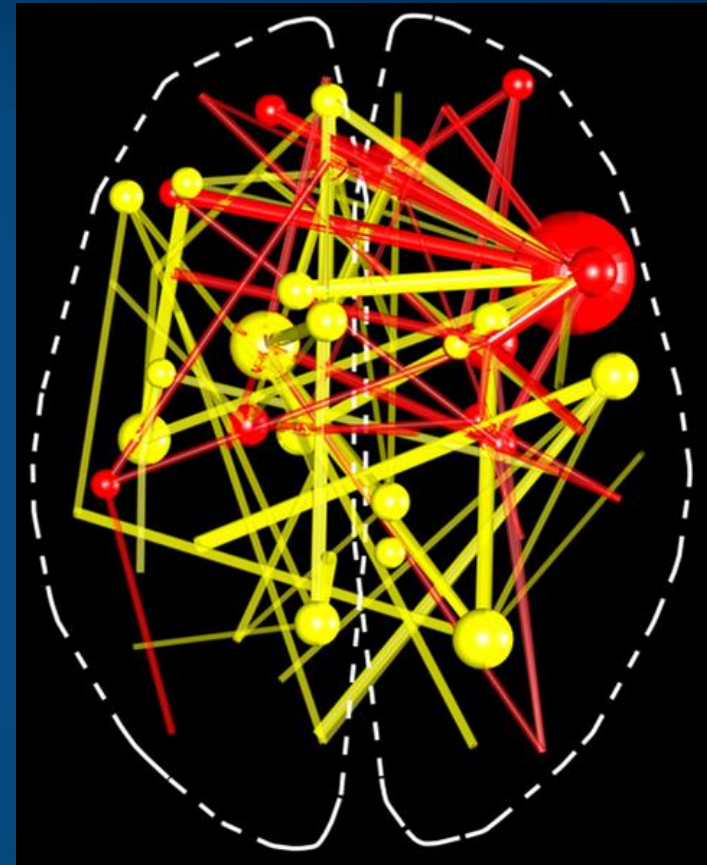

AI and abstract models of mind/brain

AI in Europe



**Communication From The European Commission, Brussels, 25.4.2018
Artificial Intelligence for Europe.**

“Like the steam engine or electricity in the past, AI is transforming our world, our society and our industry. AI is one of the most strategic technologies of the 21st century. The stakes could not be higher. The way we approach AI will define the world we live in.”

In the period 2014-2017 around 1.1 B€ has been invested in AI-related research and innovation under the Horizon 2020, in big data, health, rehabilitation, transport and space-oriented research. Investments in neuromorphic chips, high-performance computers, flagship projects on quantum technologies and mapping of the human brain are also important.

Public and private EU sectors should aim to invest at least 20 B€ by the end of 2020 and more than EUR 20 billion per year over the following decade.

Pan-European network of AI excellence centers will be created.

Is it really AI revolution? Or NN, CI, ML, pattern recognition, signal processing ...

A Standard Model of the Mind

Laird JE, Lebiere C, & Rosenbloom, PS (2017). A Standard Model of the Mind: Toward a Common Computational Framework across Artificial Intelligence, Cognitive Science, Neuroscience, and Robotics. *AI Magazine*, 38, 13–26.

Laird: A mind is a functional entity that can think.

Newell: Mind is a control system that determines behavior of organism interacting with complex environment.

Cognitive informatics
Neurocognitive Informatics
(Deep Mind, OpenAI).

AI-NN-ML-SC-PR
communities will finally
join in problem-oriented,
not method oriented,
large-scale projects.

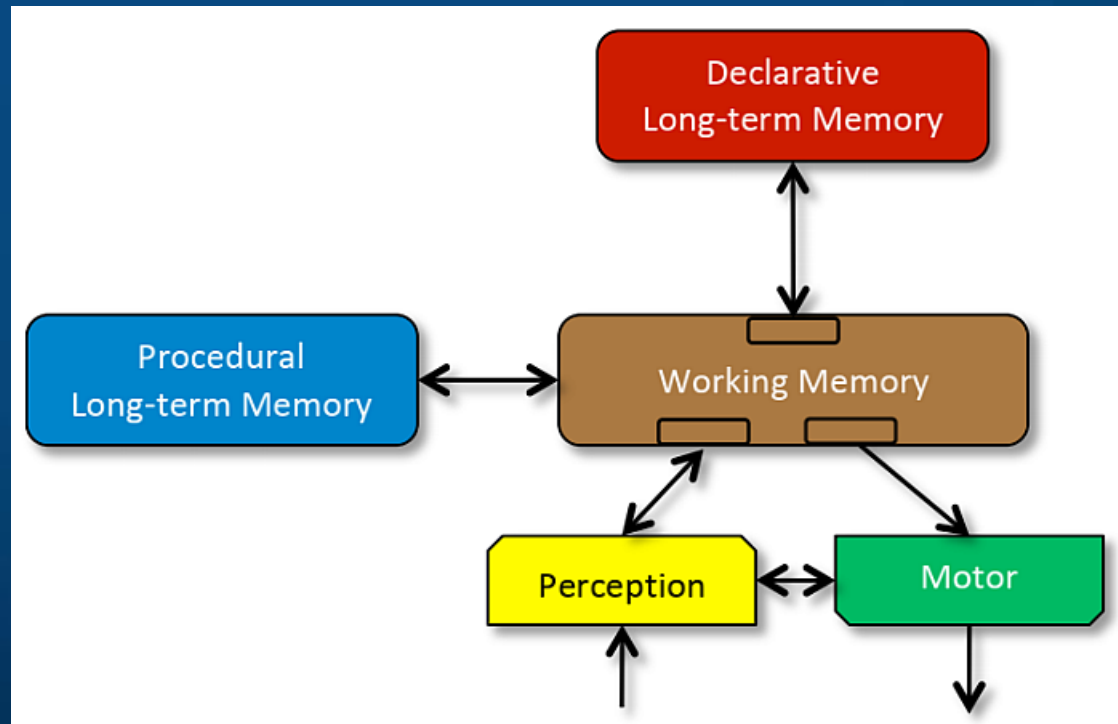

Unified theories of brain functions

Physics: principle of least action => laws of mechanics: Newtonian, Lagrangian, Hamiltonian, and general relativity (Hilbert) equations of motion.

Artificial Intelligence: search in problem spaces (Newell, Simon).

Cognitive systems: minimization of surprise or prediction errors, active inference, self-organization to minimize surprise (sensory), ensure homeostasis, select a limited number of internal action states.

Mathematical formulation is based on variational Bayesian methods.

Behavior = F(Brain State, Sensations).

Brain State depends on stimuli s and latent internal parameters ν of the model (agent) m while surprise is measured by entropy:

$$\begin{aligned}\mathcal{H} &= \int_0^T dt \mathcal{L}(m, s, t) = - \int \ln p(s(t) | m(\mathcal{G}(t))) d\mathcal{G} \\ &= - \int p(\mathcal{G} | m) \ln p(\mathcal{G} | m) d\mathcal{G}\end{aligned}$$

Free energy

We do not know the latent parameters ν of the model, but may estimate free energy to find the upper bound:

$$\mathcal{F}(t) \geq \mathcal{L}(t)$$

Free energy principle (Friston): an information theory measure F that bounds from above the surprise on sampling some data, given a generative model.

Maximum a posteriori estimation (MAP estimation) \leq EM (expectation-maximization) algorithm extension from single most probable value of hidden parameters to fully Bayesian estimation of an approximation to the entire posterior distribution $p(\nu|s)$ of the parameters and latent variables.

Adaptive systems (animals, brains) resist a natural tendency to disorder. Perception optimizes predictions. Action minimizes prediction errors.

The free-energy principle (FEP): any self-organizing system that is at equilibrium with its environment must minimize its free energy.

Free energy

The free-energy principle (FEP): any self-organizing system that is at equilibrium with its environment must minimize its free energy – predict = active inference.

Constraints for brain architecture: EST, Evolutionary Systems Theory (Badcock, 2012).

Combination of FEP with EST is a candidate for standard theory of cognitive systems.

Still only a sketch of a theory. Can FEP be derived from computational neuroscience?

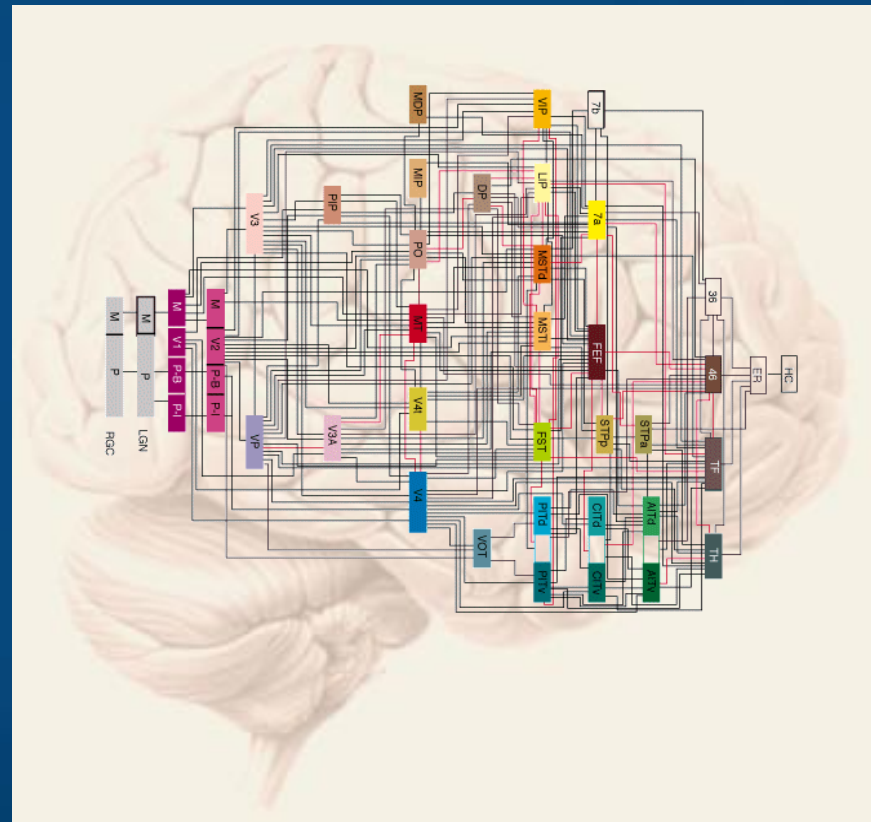

Hierarchical brain structure

Back of the brain – forward prediction error.

Front of the brain – backward predictions.

Park H-J, Friston K.

Structural and functional brain networks: from connections to cognition. Science. 2013;342

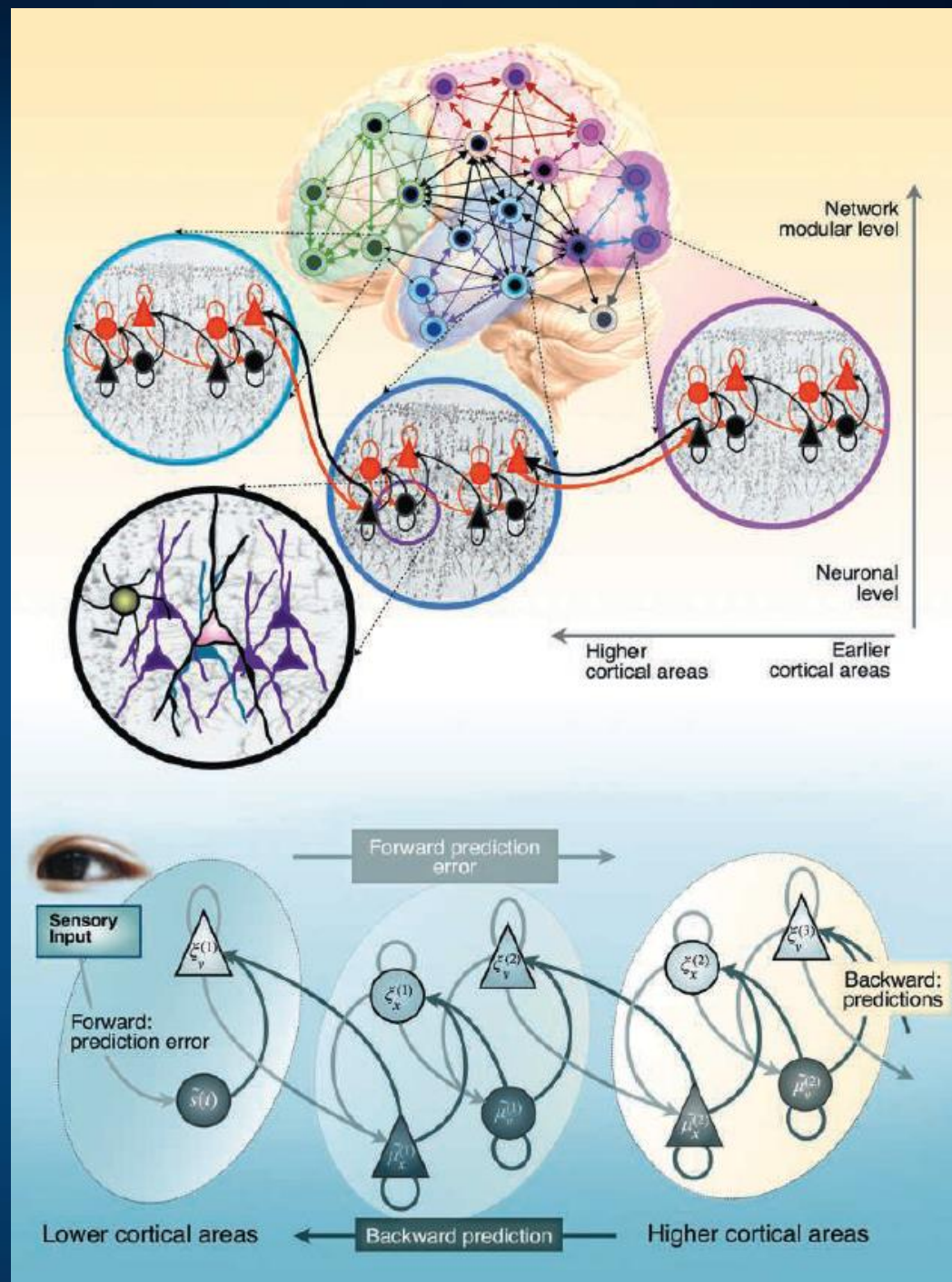

Brain networks.
Space for neurodynamics.

Geometric model of mind

Brain \leftrightarrow Psyche

Objective \leftrightarrow Subjective

Neurodynamics: bioelectrical activity of the brain, neural activity measured using EEG, MEG, NIRS-OT, PET, fMRI, other techniques.

Mapping $S(M) \leftrightarrow S(B)$ but how do we describe the state of mind?

Verbal description is not sufficient.

A space with dimensions that measure different aspects of experience is needed.

Mental states, movement of thoughts \leftrightarrow trajectories in psychological spaces.

Problem: good phenomenology. We are not able to describe our mental states.

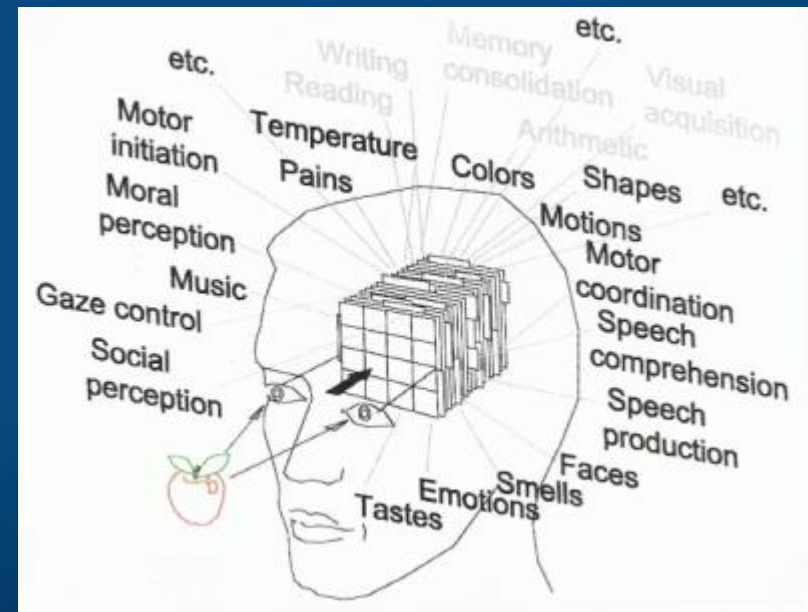
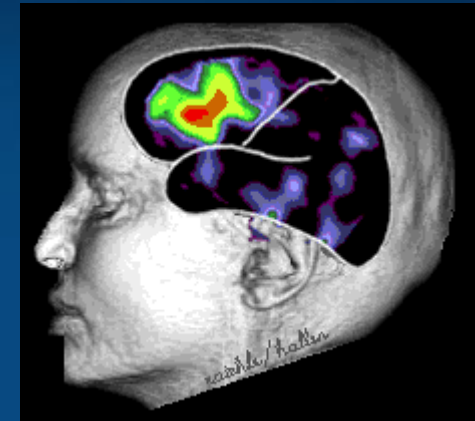

Hurlburt & Schwitzgabel, Describing Inner Experience? MIT Press 2007

Mental state: strong coherent activation

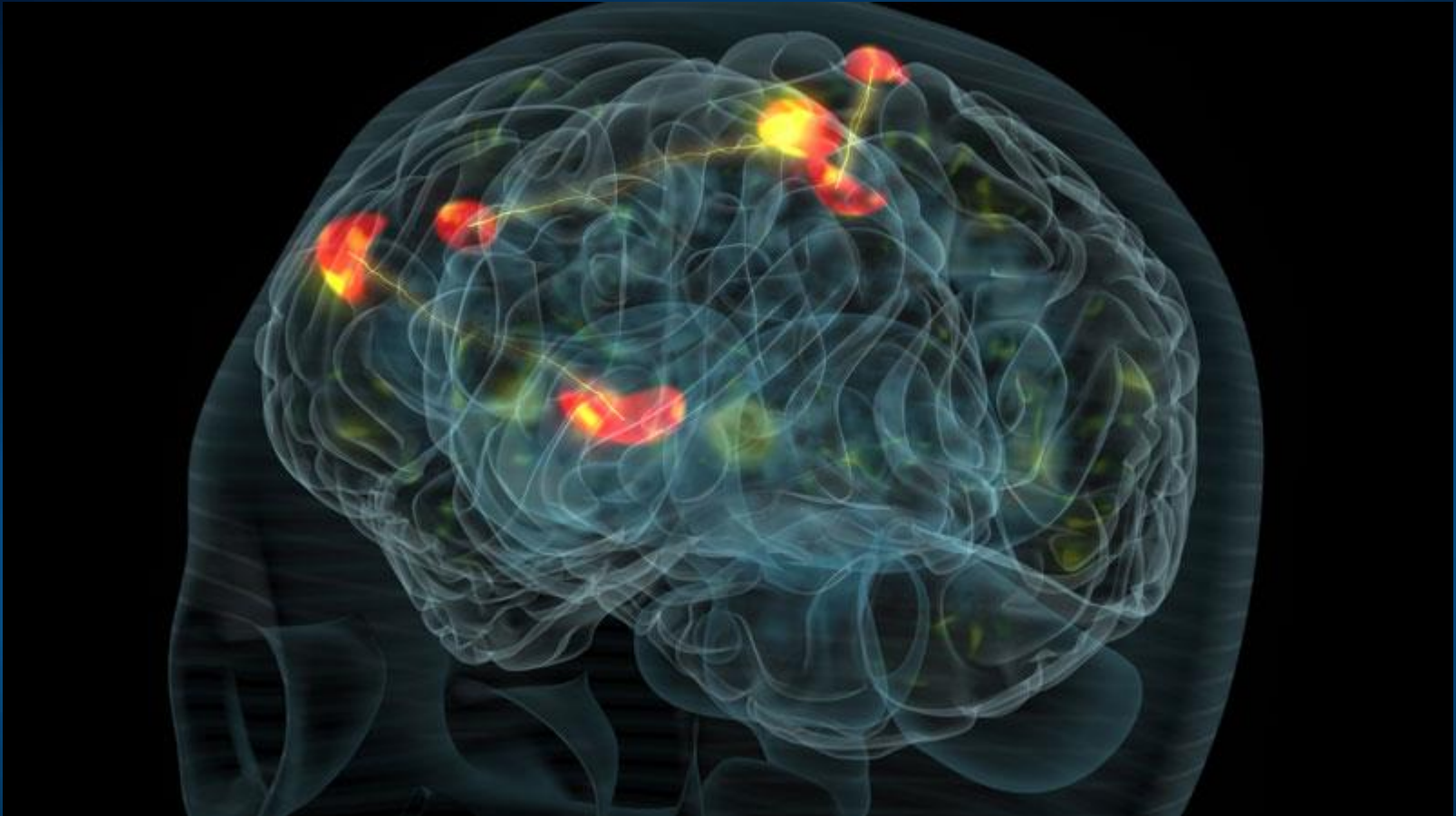

Many processes go on in parallel, controlling homeostasis and behavior. Most are automatic, hidden from our Self. What goes on in my head? Various subnetworks compete for access to the highest level of control - consciousness, the winner-takes-most mechanism leaves only the strongest. How to extract stable intentions from such chaos? BCI is never easy.

In search of the sources of brain's cognitive activity

Project „Symfonia”, NCN, Kraków, 18 July 2016



Looking for a postdock (5/2018)!

Brain networks: canvas for the mind

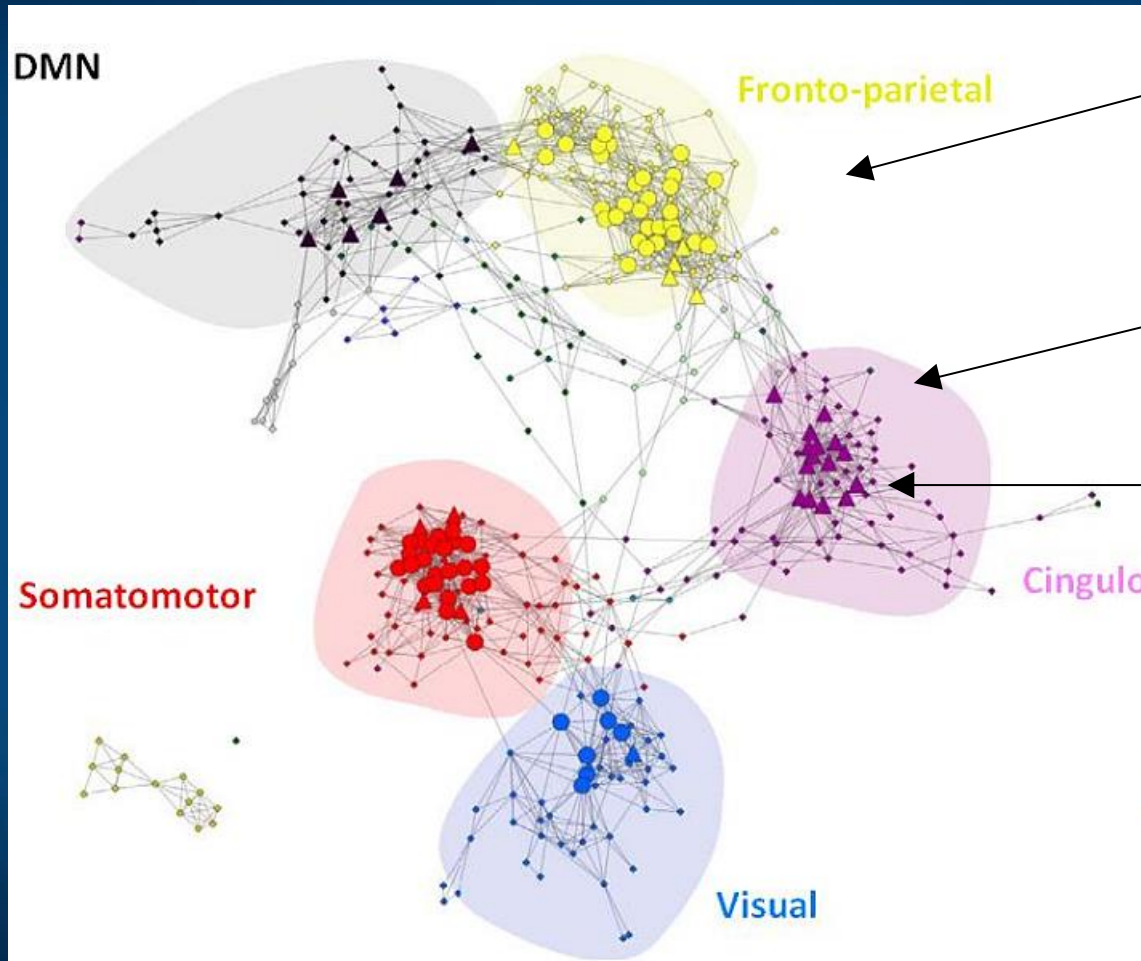

ROI=brain Regions of Interest

Connections

Nodes

Neurocognitive Basis of Cognitive Control

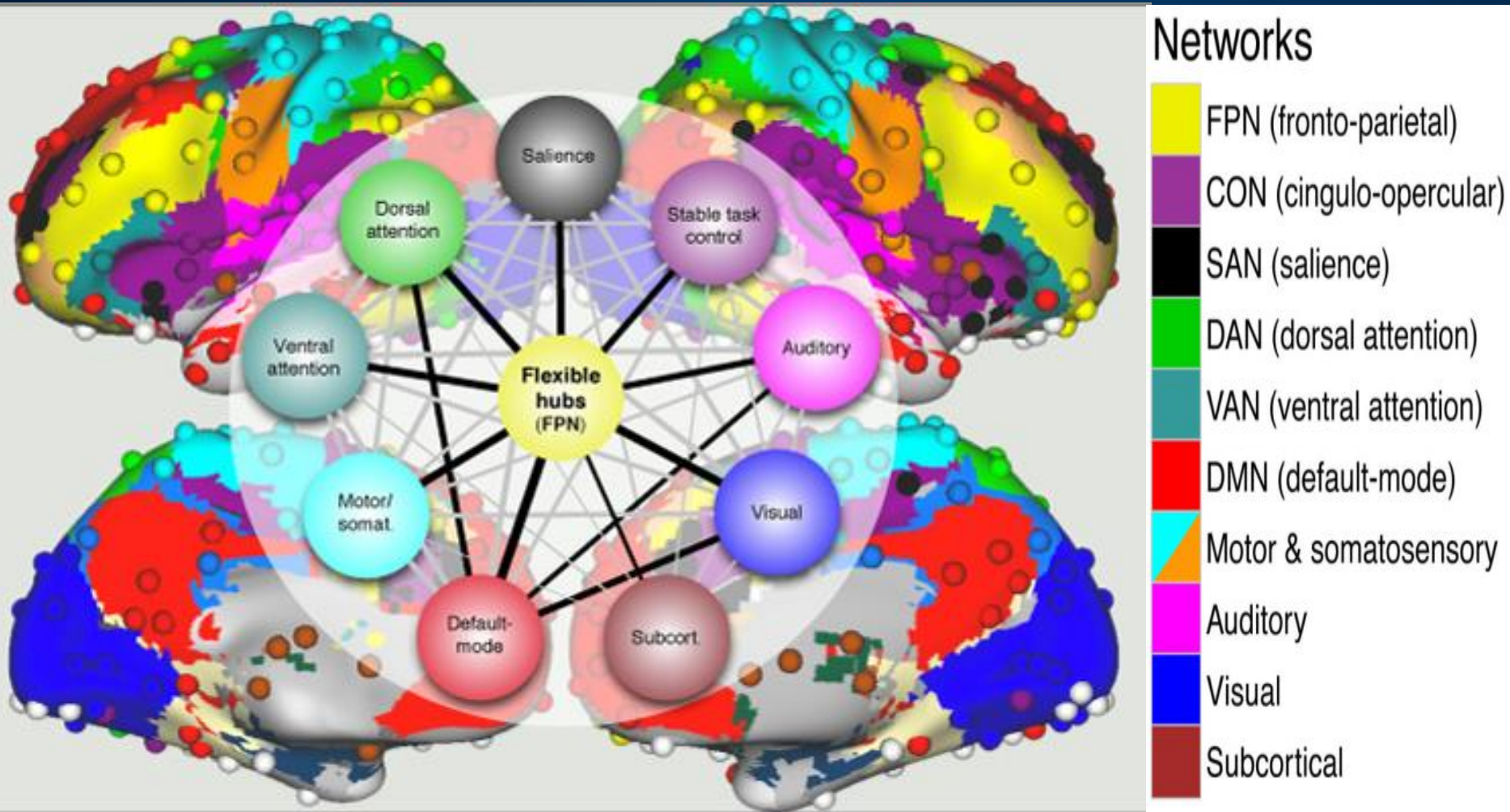

Central role for fronto-parietal (FPN) flexible hubs in cognitive control and adaptive implementation of task demands (black lines=correlations significantly above network average). Cole et al. (2013).

RDoC networks

aMPFC=anterior medial PFC
 AG=angular gyrus. PCC=posterior cingulate cortex; dACC=dorsal anterior CC; al=anterior insula. TP=temporal pole. SLEA=sublenticular extended amygdala.
 LPFC=lateral PFC, M=medial v=ventral, ms=medial superior, vM =ventromedial, alPL=anterior inferior parietal lobule.
 OFC=orbitofrontal cortex.
 ACC=anterior cingulate cortex.
 DLPFC=dorsolateral PCG=precentral gyrus. DPC=dorsal parietal cortex.

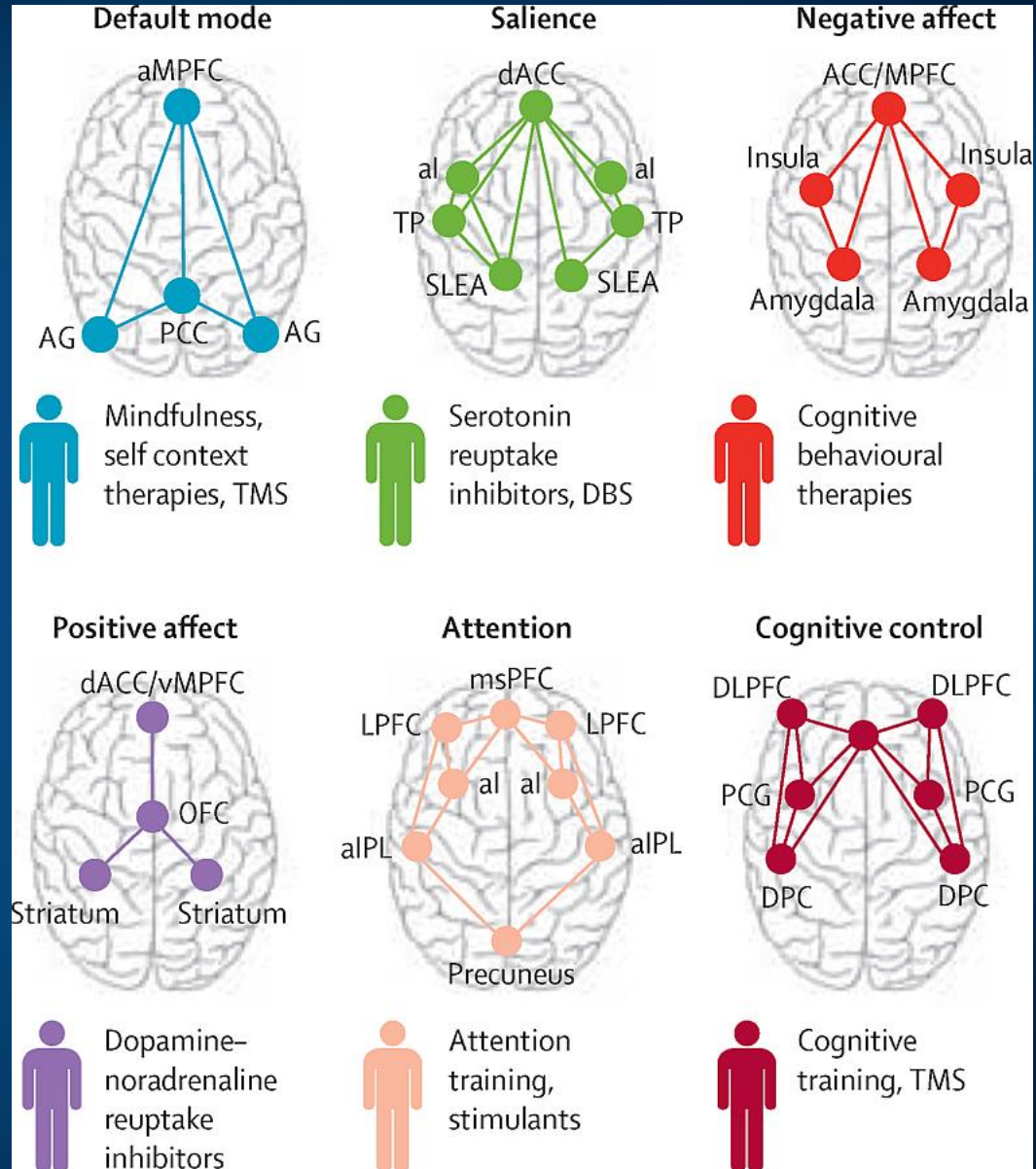

Possible form of Brain Fingerprints

fMRI: BFP is based on $V(\mathbf{X},t)$ voxel intensity BOLD signal changes, contrasted between task and reference activity or resting state.

EEG: spatial, spatio-temporal, ERP maps/shapes, coherence, various phase synchronization indices.

1. **Spatial/Power:** direct localization/reconstruction of sources.
2. **Spatial/Synch:** changes in functional graph network structure.
3. **Frequency/Power:** ERS/ERD smoothed patterns $E(\mathbf{X},t,f)$.
4. **ERP power maps:** spatio-temporal averaged energy distributions.
5. **EEG decomposition into components:** ICA, CCA, tensor, RP ...
6. **EEG microstates, sequences & transitions, dynamics in ROI space.**
7. **Model-based: The Virtual Brain,** integrating EEG/neuroimaging data.
8. **Spectral fingerprinting (MEG, EEG), power distributions.**

Neuroplastic changes of connectomes and functional connections as results of training for optimization of brain processes.

Functional connectivity changes

Influence of brain games on functional connectivity: **Phase Locking Value** (Burgess, 2013; Lachaux 1999), phase differences between signals measured at each electrode. PLV => synchronization maps, info flow.

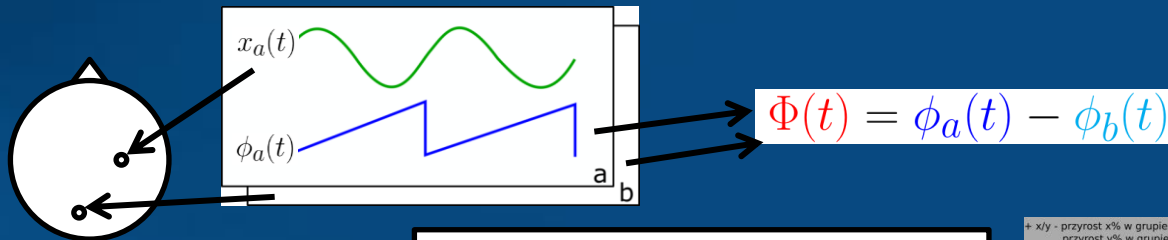

$$PLV(a, b) = \frac{1}{T} \left| \sum_t e^{i\Phi(t)} \right|$$

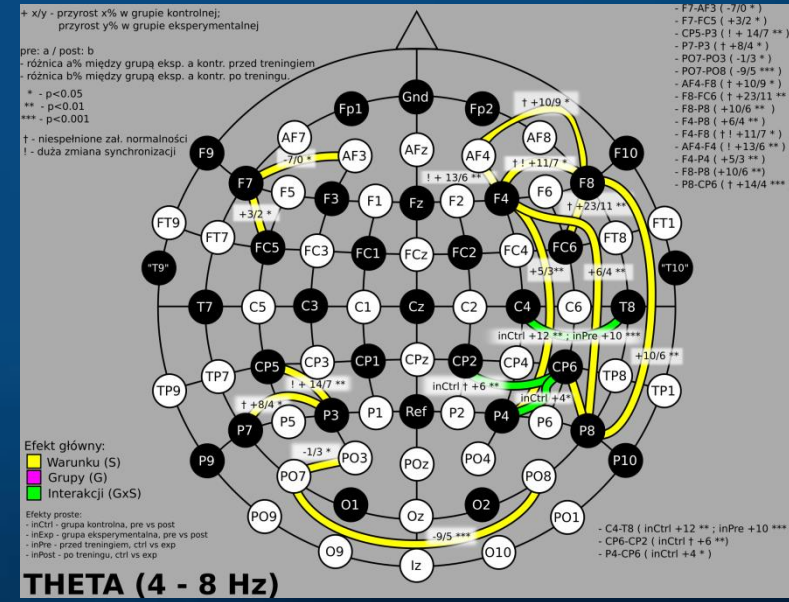
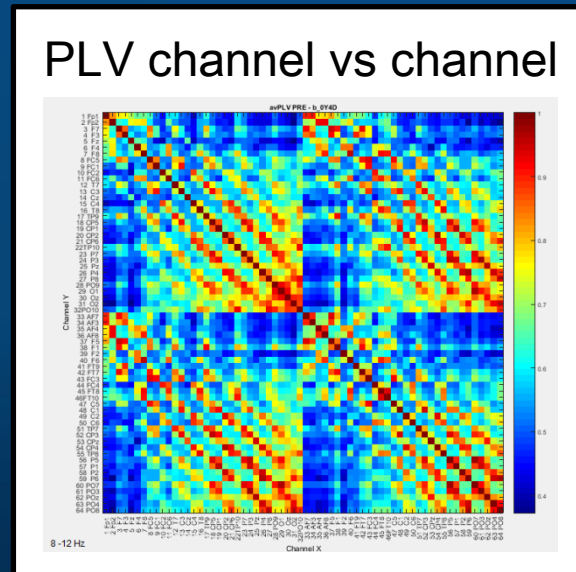

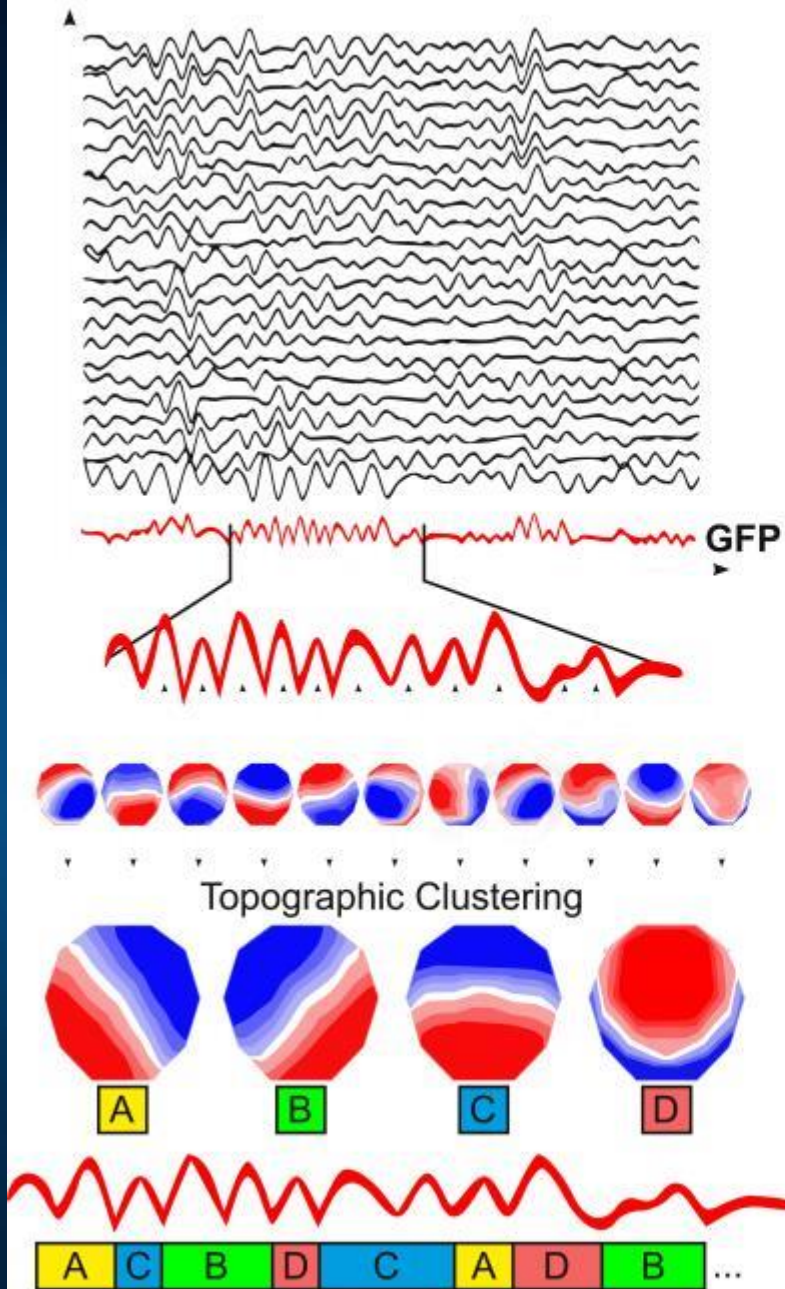
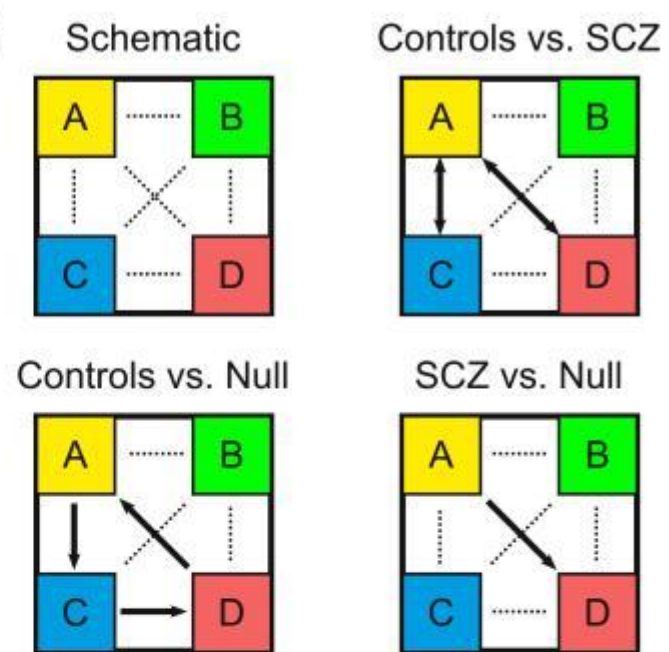
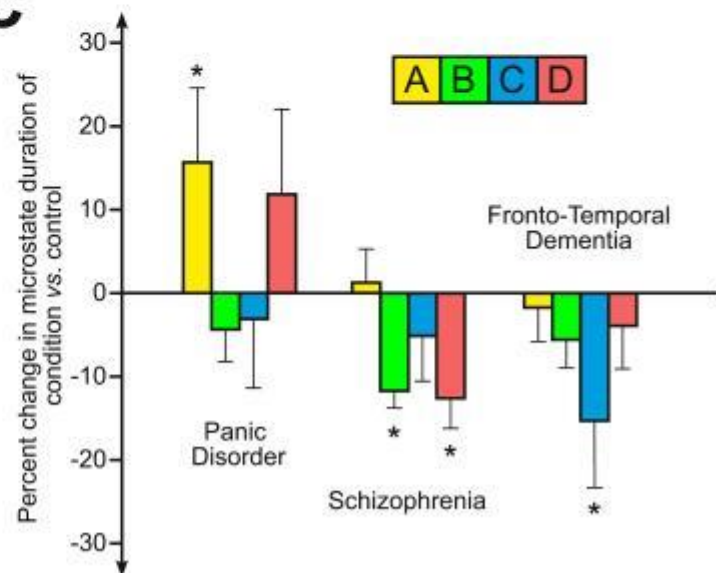
A**B****C**

Human connectome and MRI/fMRI

Structural connectivity

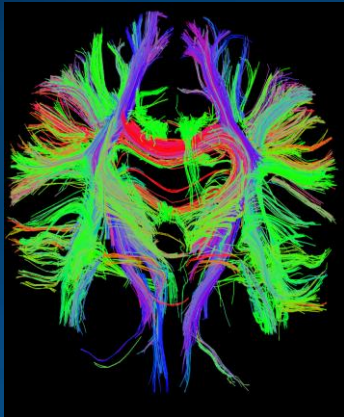

Functional connectivity

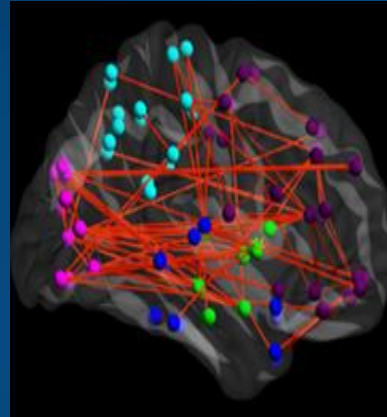

Node definition (parcelation)

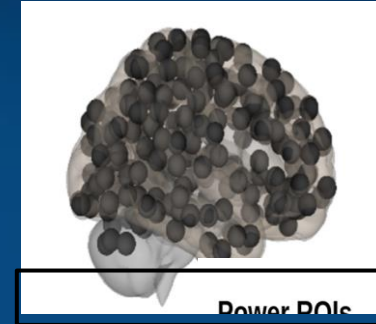

Signal extraction

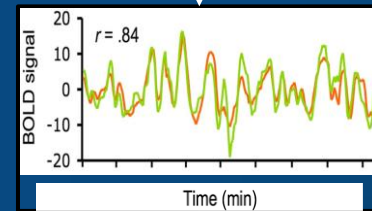

Correlation calculation

Binary matrix



Correlation matrix

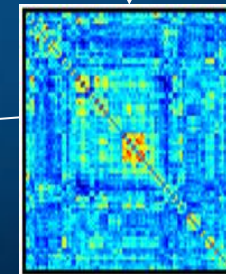

Graph theory

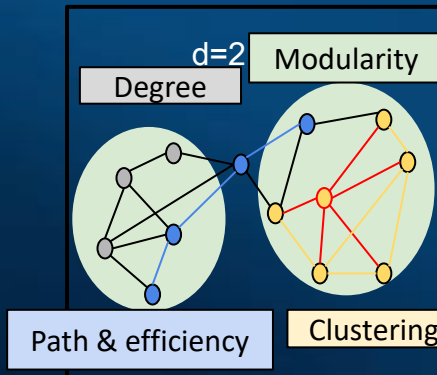

Whole-brain graph

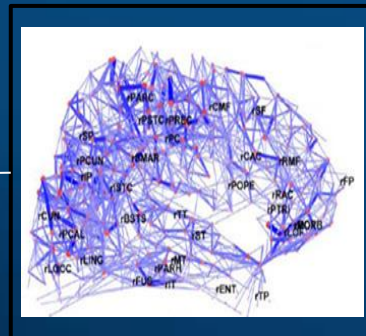

Many toolboxes available for such analysis.

Bullmore & Sporns (2009)

Ciric et.al. (2017). Contextual connectivity: A framework for understanding the intrinsic dynamic architecture of large-scale functional brain networks. *Scientific Reports*.

Correlations of 6 canonical networks.

Perception,
Action-attention
DMN (Default Mode Network)

Each has up to 10 different network connectivity states (NC-states), rather stable for single subjects, ex. DMN has usually 7-9.

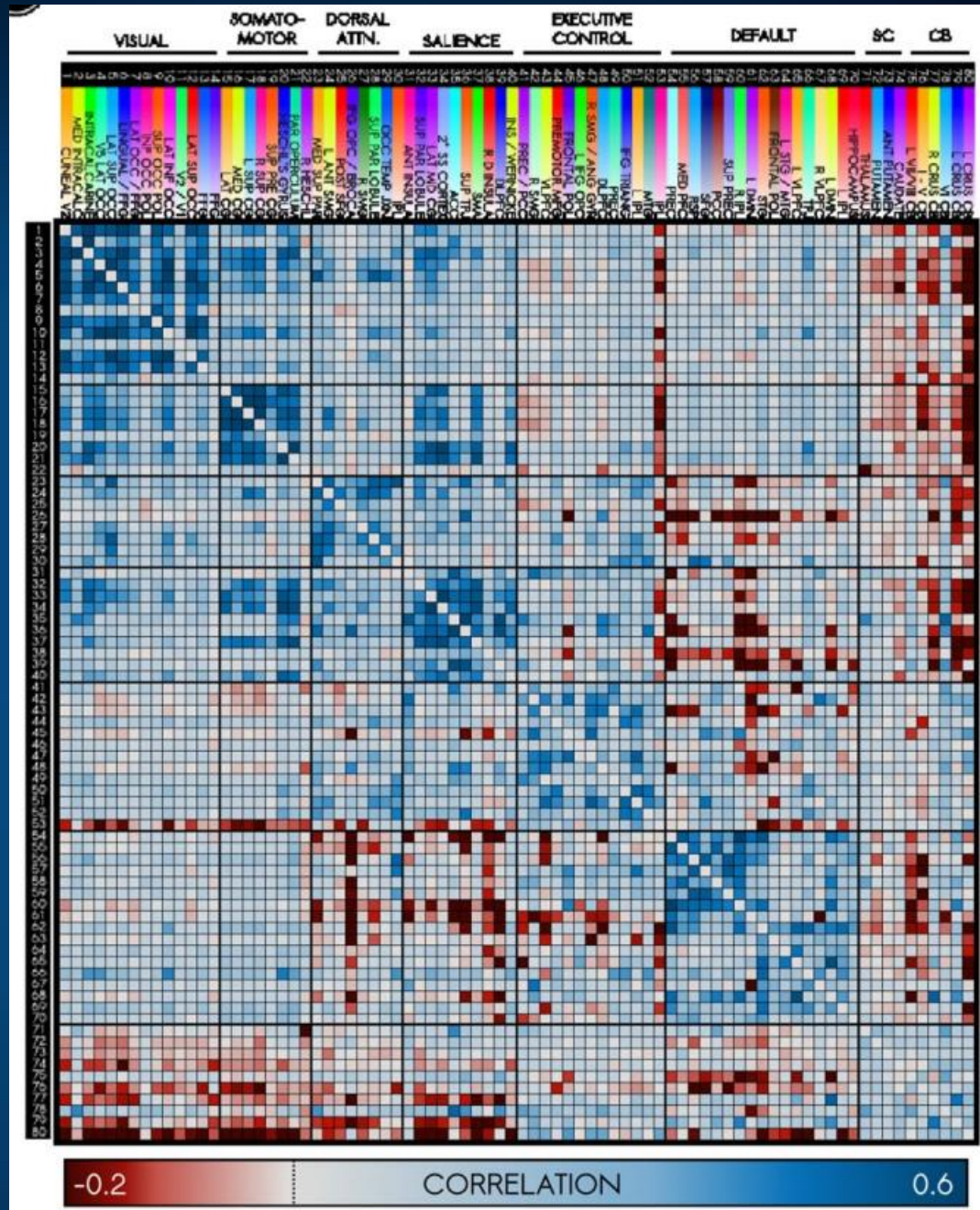

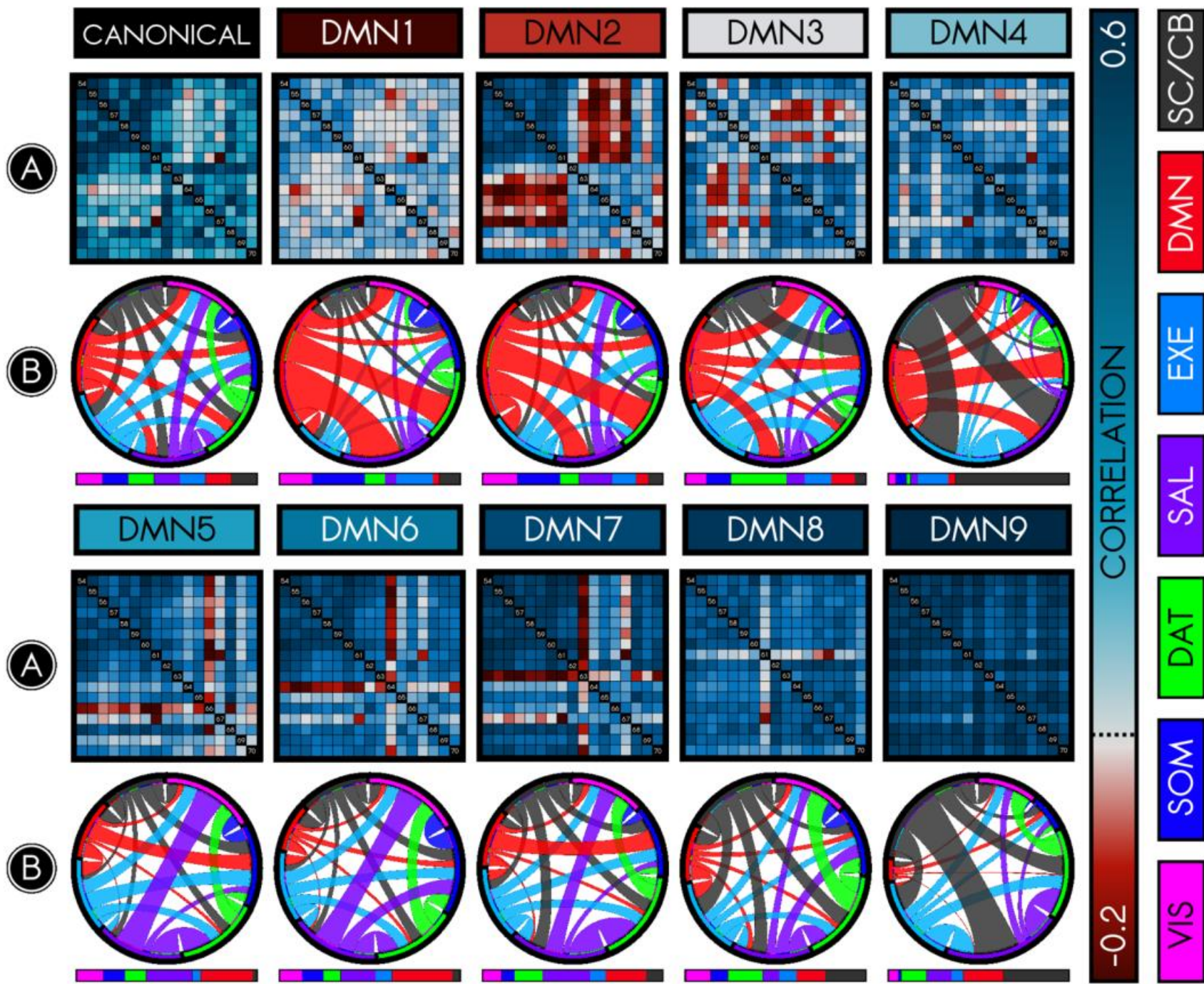

Finn et al. (2015), **Functional connectome fingerprinting**: identifying individuals using patterns of brain connectivity. Nature Neuroscience. Top: highly unique; Bottom: highly consistent connections.

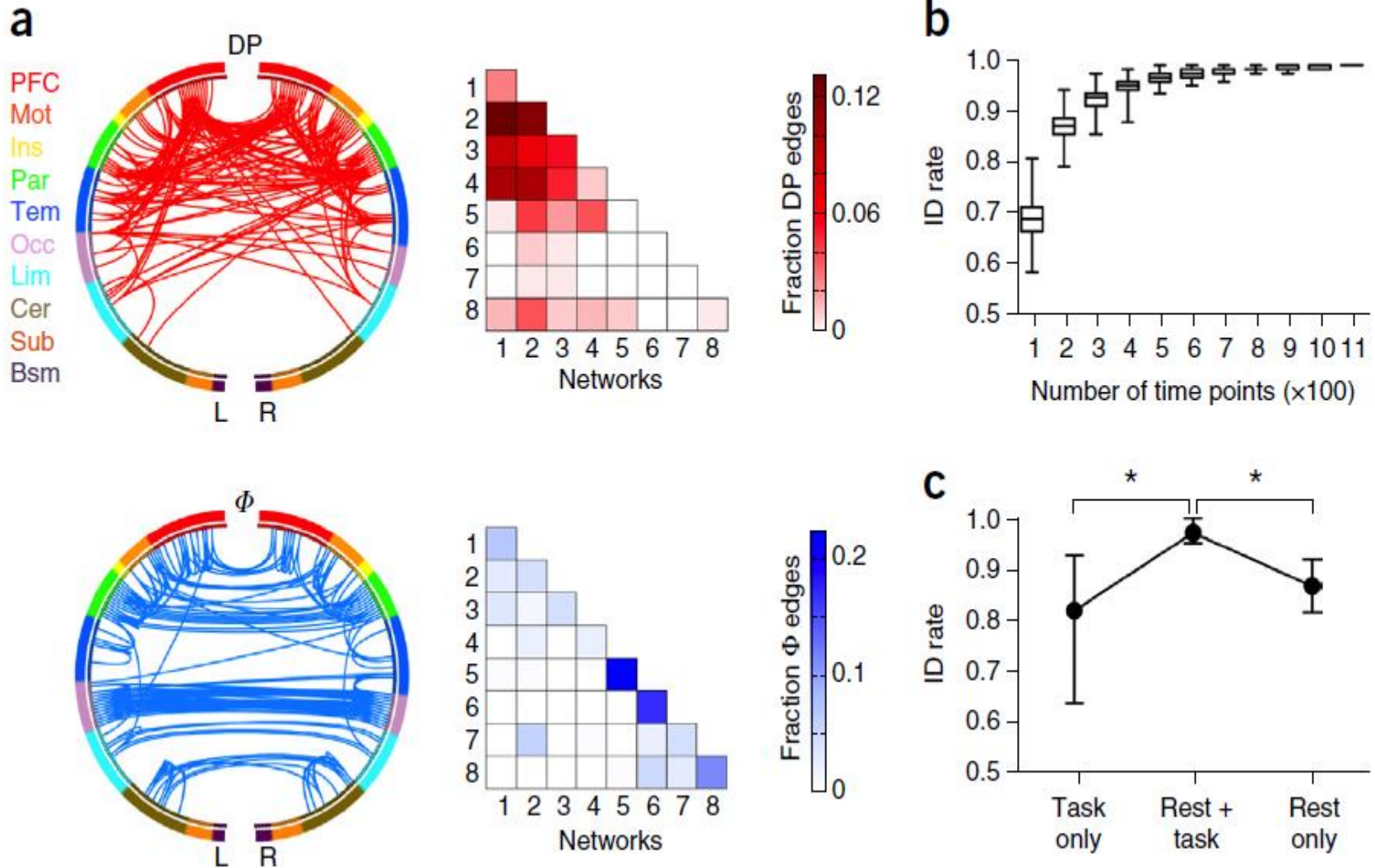

ASD: pathological connections

Comparison of connections for patients with ASD (autism spectrum), TSC (Tuberous Sclerosis), and ASD+TSC.

Coherence between electrodes. Weak or missing connections between distant regions prevent ASD/TSC patients from solving more demanding cognitive tasks.

Network analysis becomes very useful for diagnosis of changes due to the disease and learning; **correct your networks!**

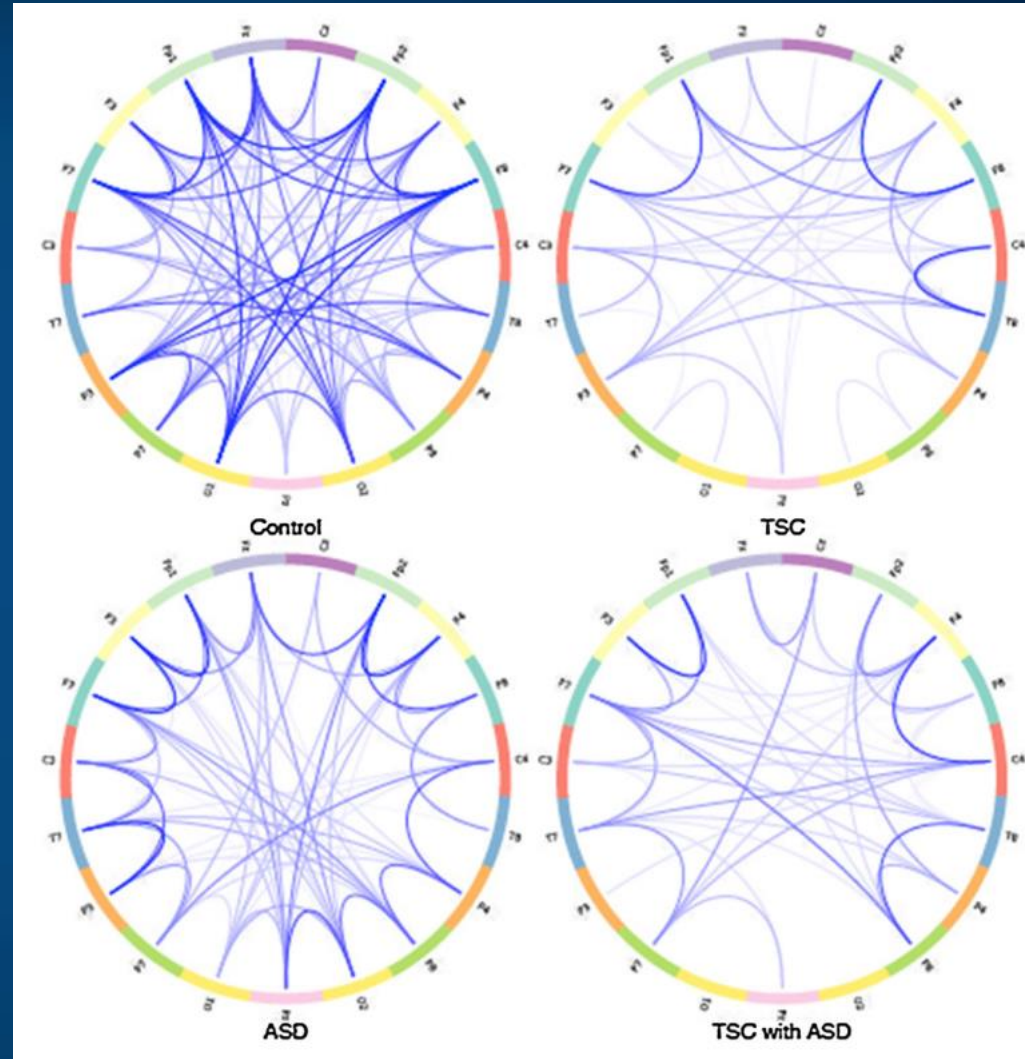

J.F. Glazebrook, R. Wallace, Pathologies in functional connectivity, feedback control and robustness. *Cogn Process* (2015) 16:1–16

Selected connections

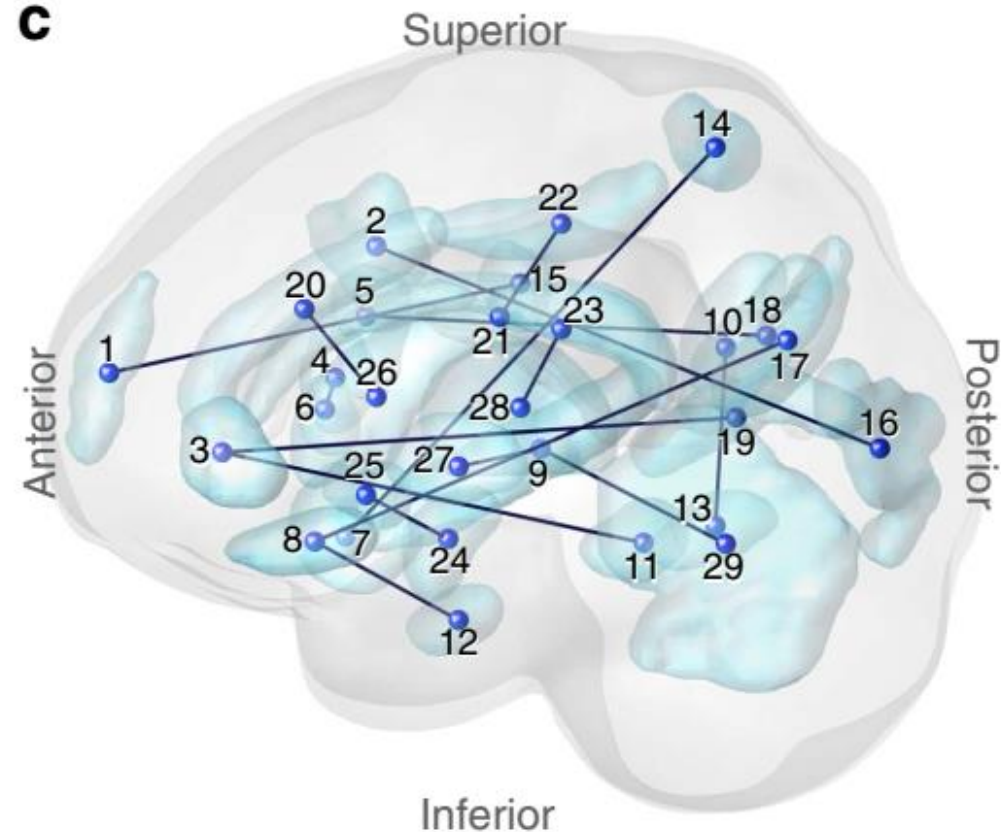
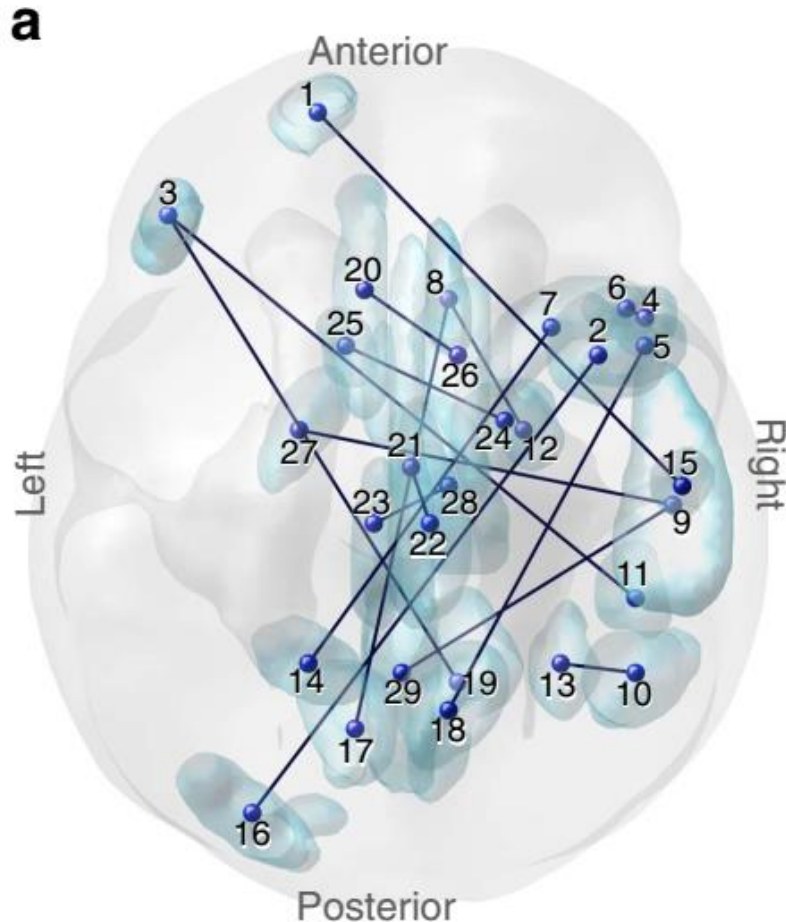

N. Yahata et al, 29 selected regions (ROI) and 16 connections were sufficient to recognize ASD with 85% accuracy in 74 Japanese adult patients vs. 107 people in control group; without re-training accuracy was 75% on US patients. [Movie](#).

EEG early ASD detection

Bosl, W. J., Tager-Flusberg, H., & Nelson, C. A. (2018). EEG Analytics for Early Detection of Autism Spectrum Disorder: A data-driven approach. *Scientific Reports*, 8(1), 6828.

EEG of 3-month old, 19 electrodes (from 64 or 128) selected.

Daubechies (DB4) wavelets transform EEG signal into 6 bands.

7 features from Recurrence Quantitative Analysis (RQA): RP entropy, recurrence rate, laminarity, repetition, max/mean line length, trapping time.

In addition sample entropy and Detrended Fluctuation Analysis was used.

Nonlinear features were computed from EEG signals and used as input to statistical learning methods. Prediction of the clinical diagnostic outcome of ASD or not ASD was highly accurate when using EEG measurements from as early as 3 months of age. SVM on 9 features gave specificity, sensitivity and PPV were high, exceeding 95% at some ages. Prediction of ADOS calibrated severity ASD scores for all infants in the study using only EEG data taken as early as 3 months of age was strongly correlated with the actual measured scores.

ASD vs Low Risk Healthy

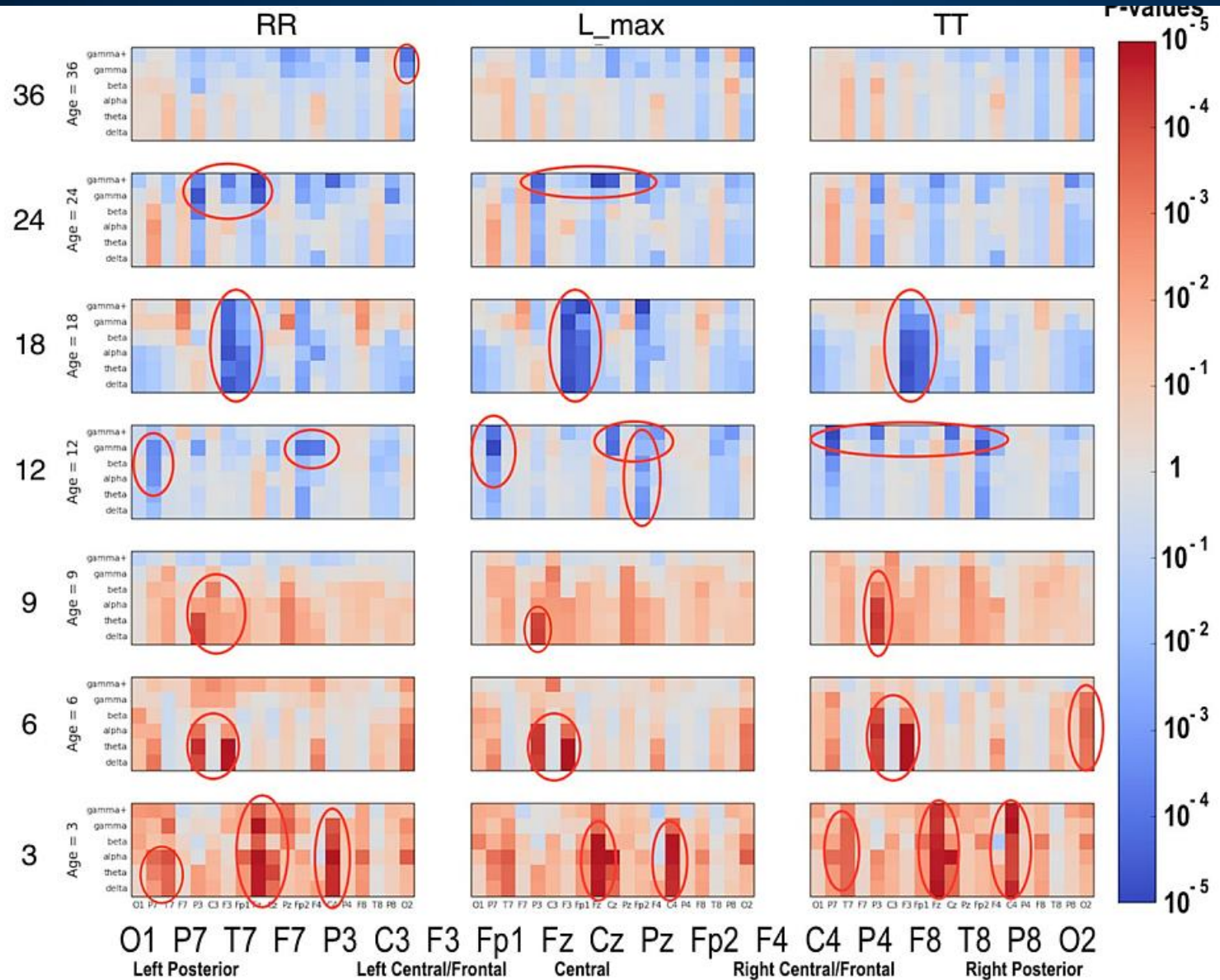

Model of reading & dyslexia

Emergent neural simulator:

Aisa, B., Mingus, B., and O'Reilly, R. The emergent neural modeling system. *Neural Networks*, 21, 1045, 2008.

3-layer model of reading:

orthography, phonology, semantics, or distribution of activity over **140 microfeatures** defining concepts.

In the brain: microfeature=subnetwork.
Hidden layers OS/OP/SP_Hid in between.

Learning: mapping one of the 3 layers to the other two.

Fluctuations around final configuration = attractors representing concepts.

How to see properties of their basins, their relations?

Model in **Genesis**: more detailed neuron description.

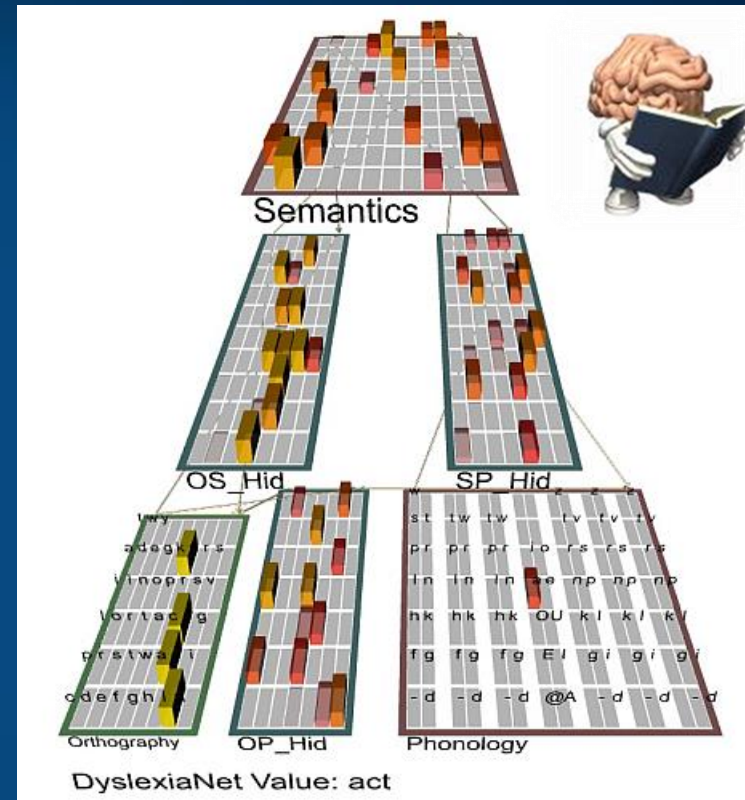

Trajectory visualization

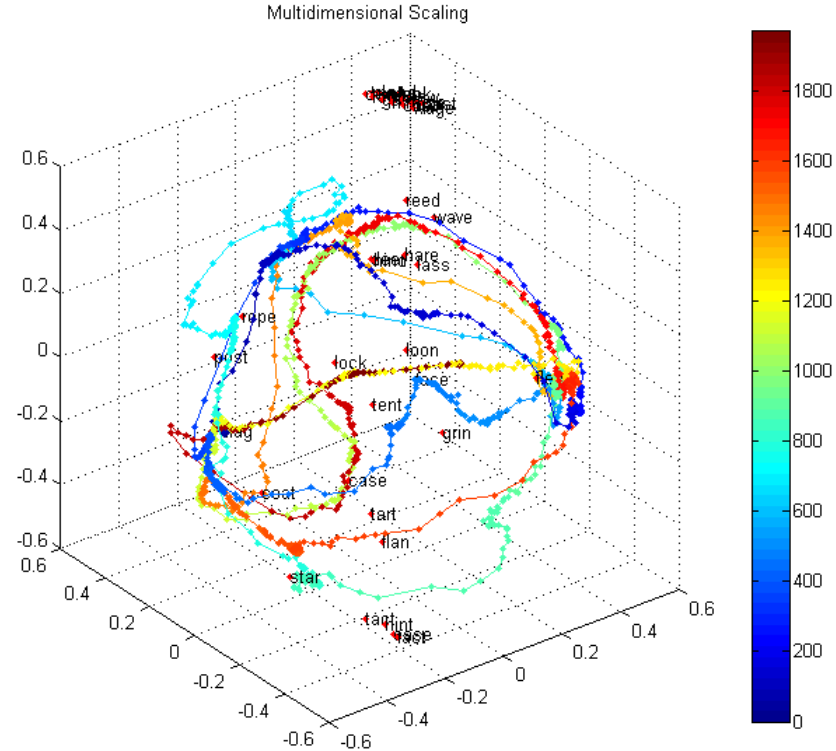
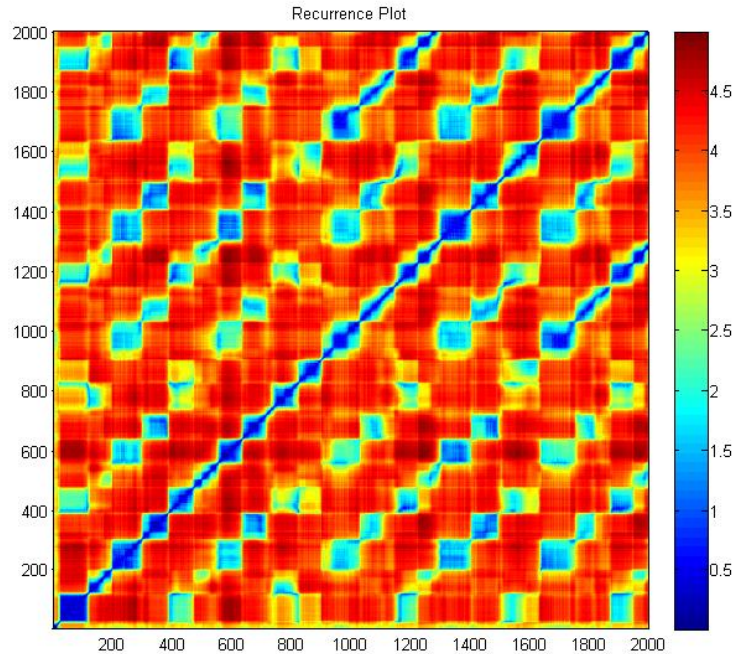

Recurrence plots and MDS/FSD/SNE visualization of trajectories of the brain activity. Here data from 140-dim semantic layer activity during spontaneous associations in the 40-words microdomain, starting with the word “flag”.

Our toolbox: <http://fizyka.umk.pl/~kdobosz/visertoolbox/>

Spectral fingerprints

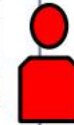
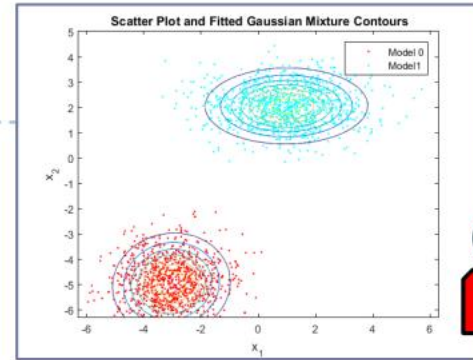
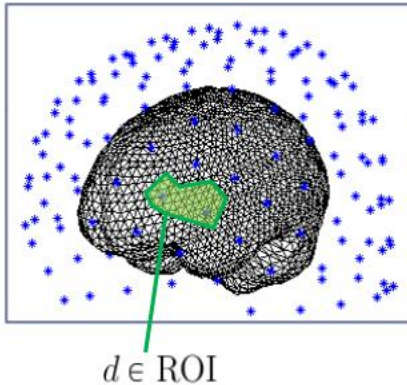

Single subject

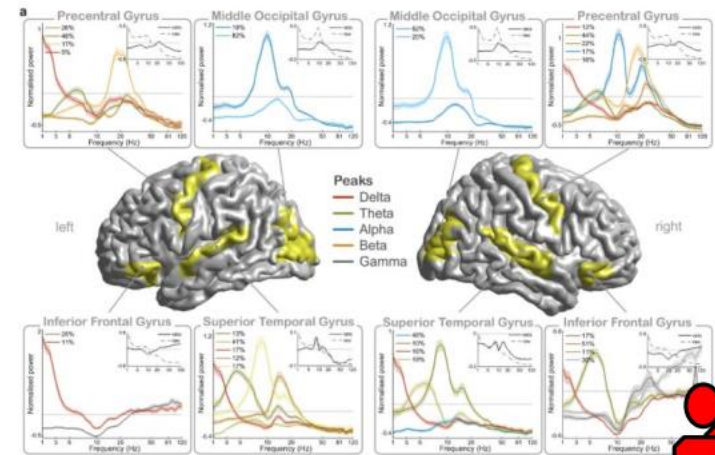
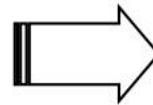
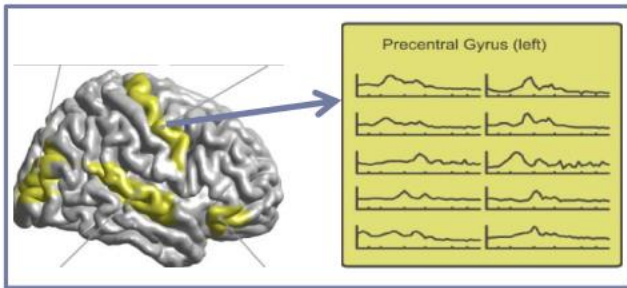

Group model

5

* Pictures from Keitel & Gross 2016 and Fieldtrip beamforming tutorial

A. Keitel & J. Gross, „Individual human brain areas can be identified from their characteristic spectral activation fingerprints”, *PLoS Biol* 14(6), e1002498, 2016

MEG-EEG preliminary comparison

Comparison between main results

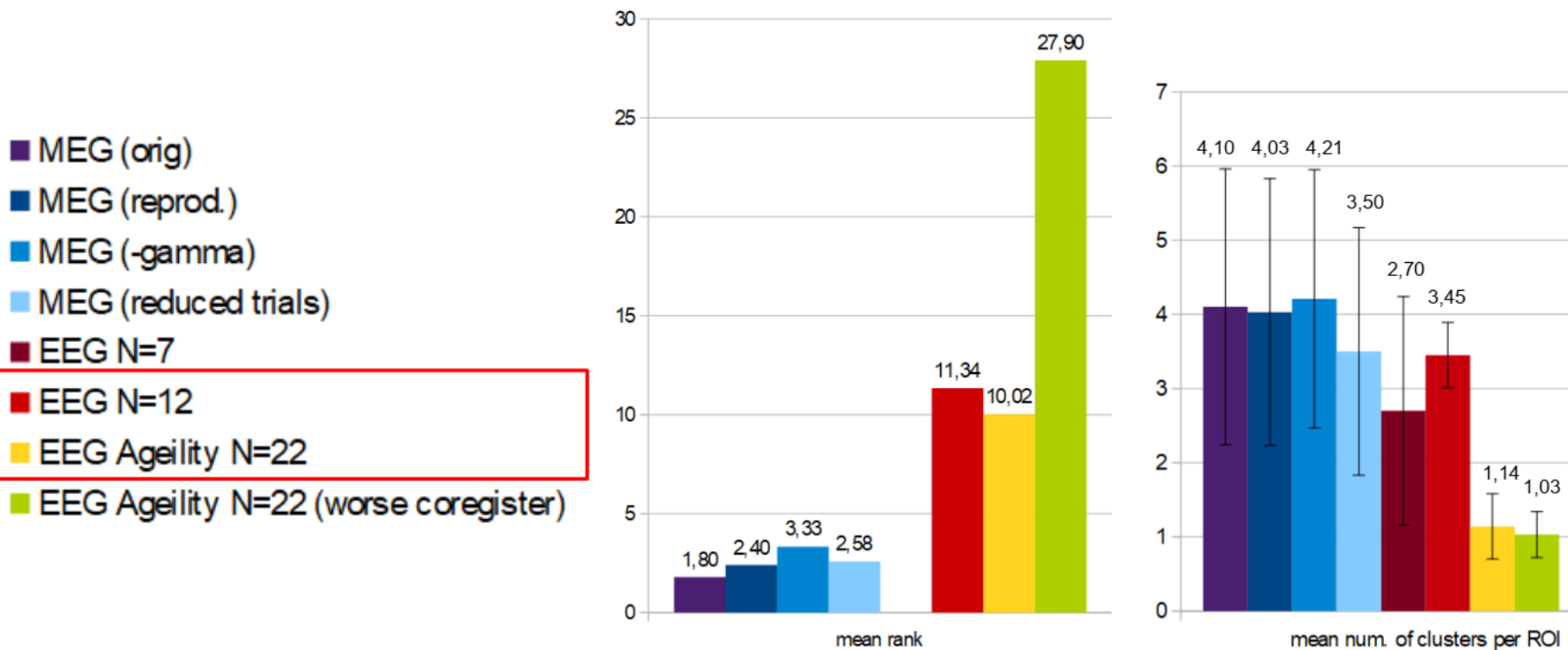

Ageility data have no information on sensor positions and results (in green) are quite poor; yellow – a bit of guessing where to place sensors on the head.

Our own experiment to collect EEG data with precise position of electrodes to enable good source reconstruction for 7 and 12 cases.

Spectral fingerprints

Left: Keitel & Gross

Avg. num. of clusters = 4.10 ± 1.86

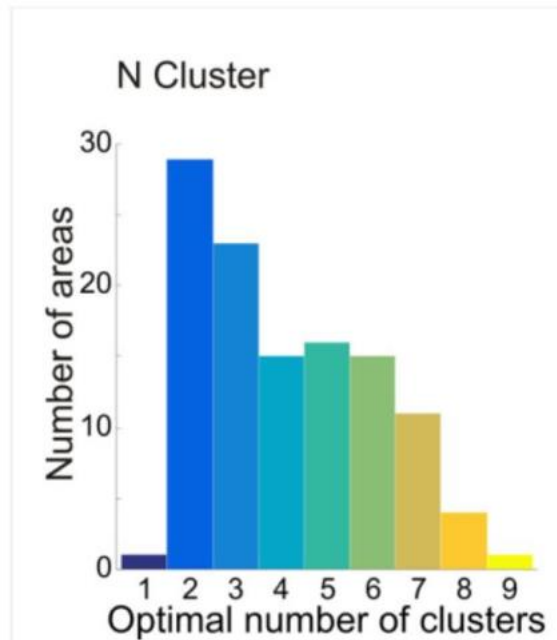

Right: EEG N=12 Torun.

Avg. num. of clusters = 3.45 ± 2.22

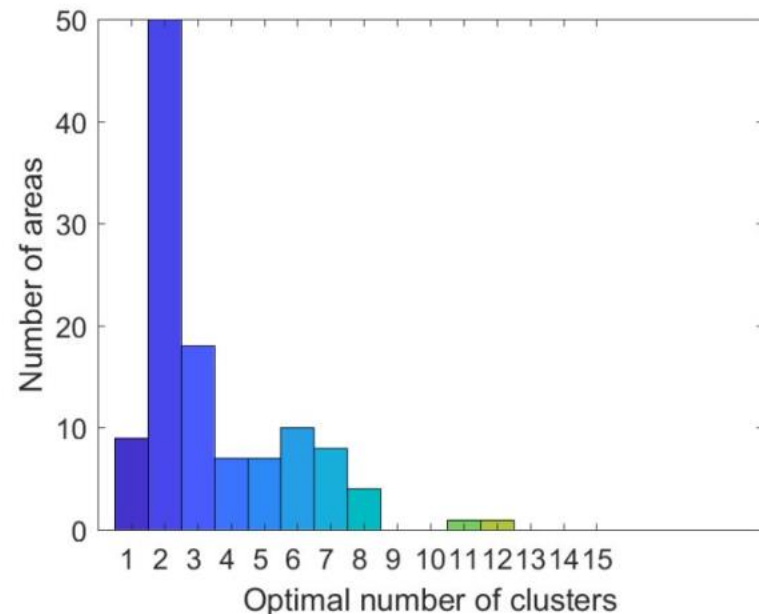

Without proper registration of sensor positions results are quite poor; we are now making our own experiment to collect EEG data with precise position of electrodes to enable good source reconstruction. In some ROI many clusters are found – sign of participation in many processes.

Spectral fingerprints

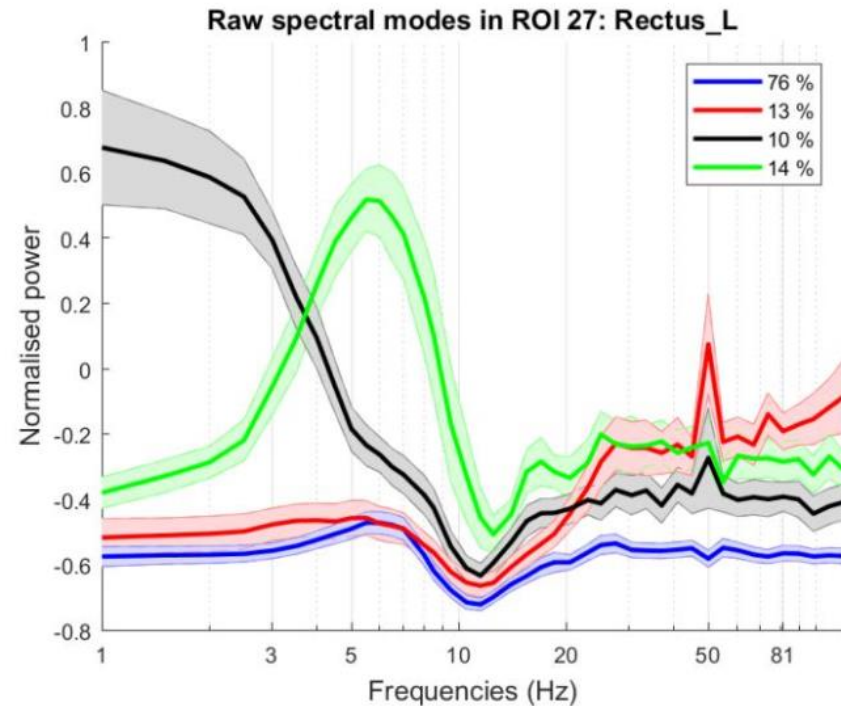
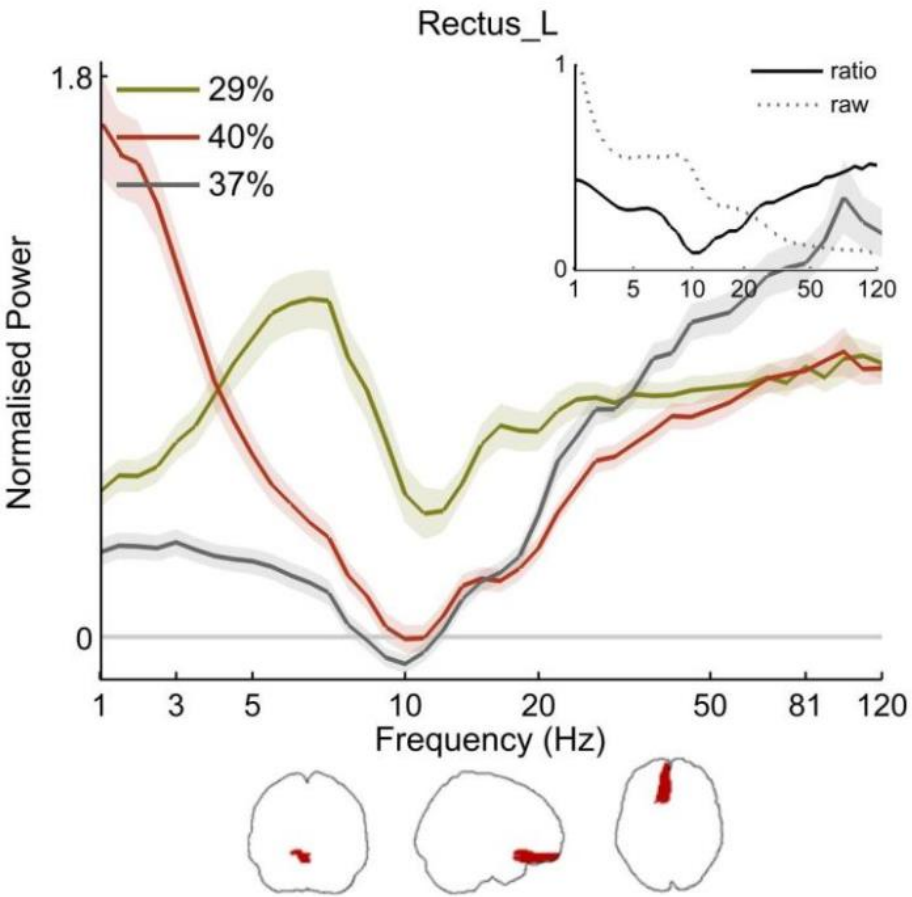

A. Keitel i J. Gross, „Individual human brain areas can be identified from their characteristic spectral activation fingerprints”, *PLoS Biol*, t. 14, nr 6, s. e1002498, 2016

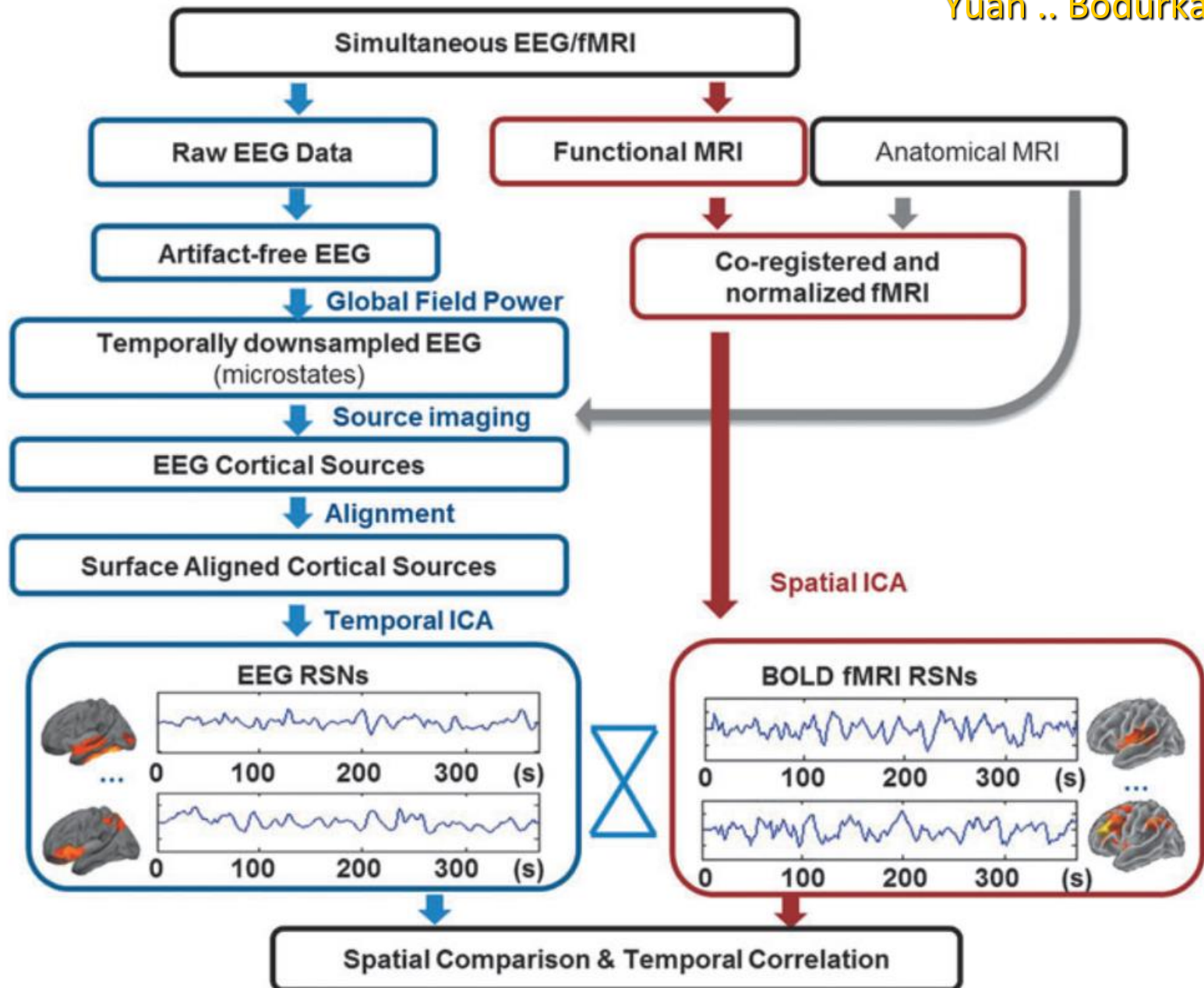

8 areas from BOLD-EEG

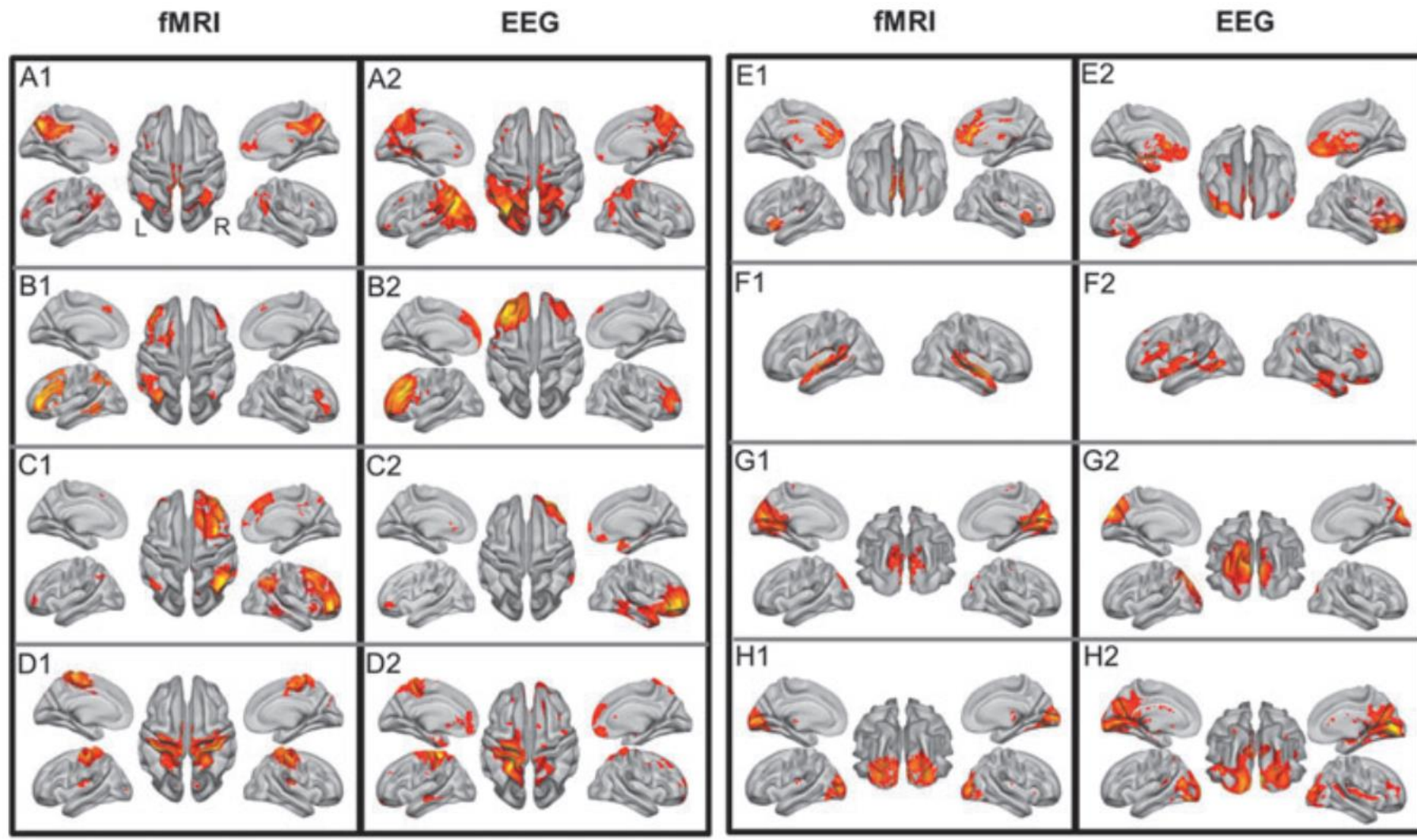

DMN, FP (frontoparietal)-left, right, sensorimotor, ex, control, auditory, visual (medial), (H) visual (lateral). Yuan ... Bodurka (2015)

14 networks from BOLD-EEG

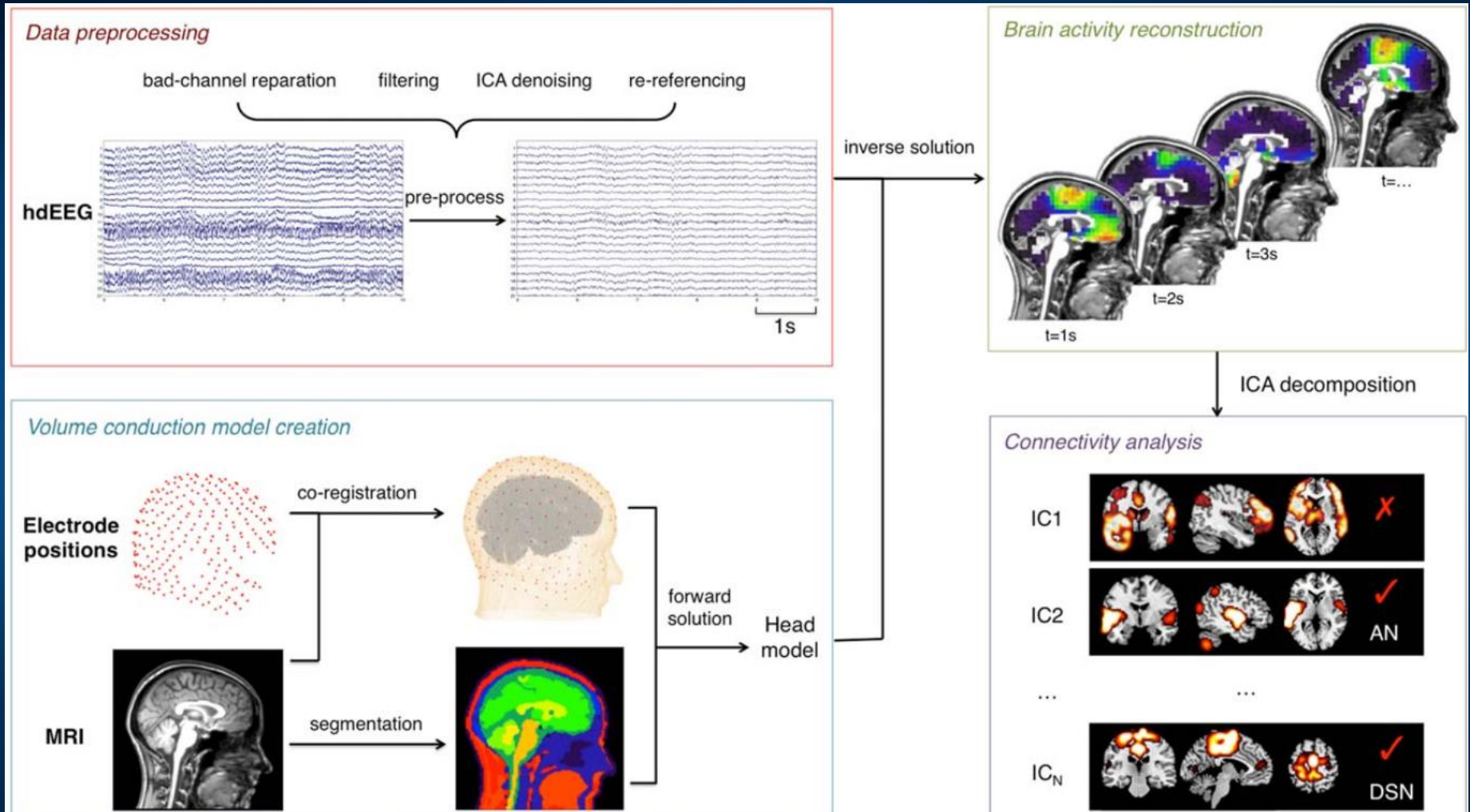

DMN, FP (frontoparietal)-left, right, sensorimotor, ex, control, auditory, visual (medial), (H) visual (lateral).

Liu et al. Detecting large-scale networks in the human brain. HBM (2017; 2018).

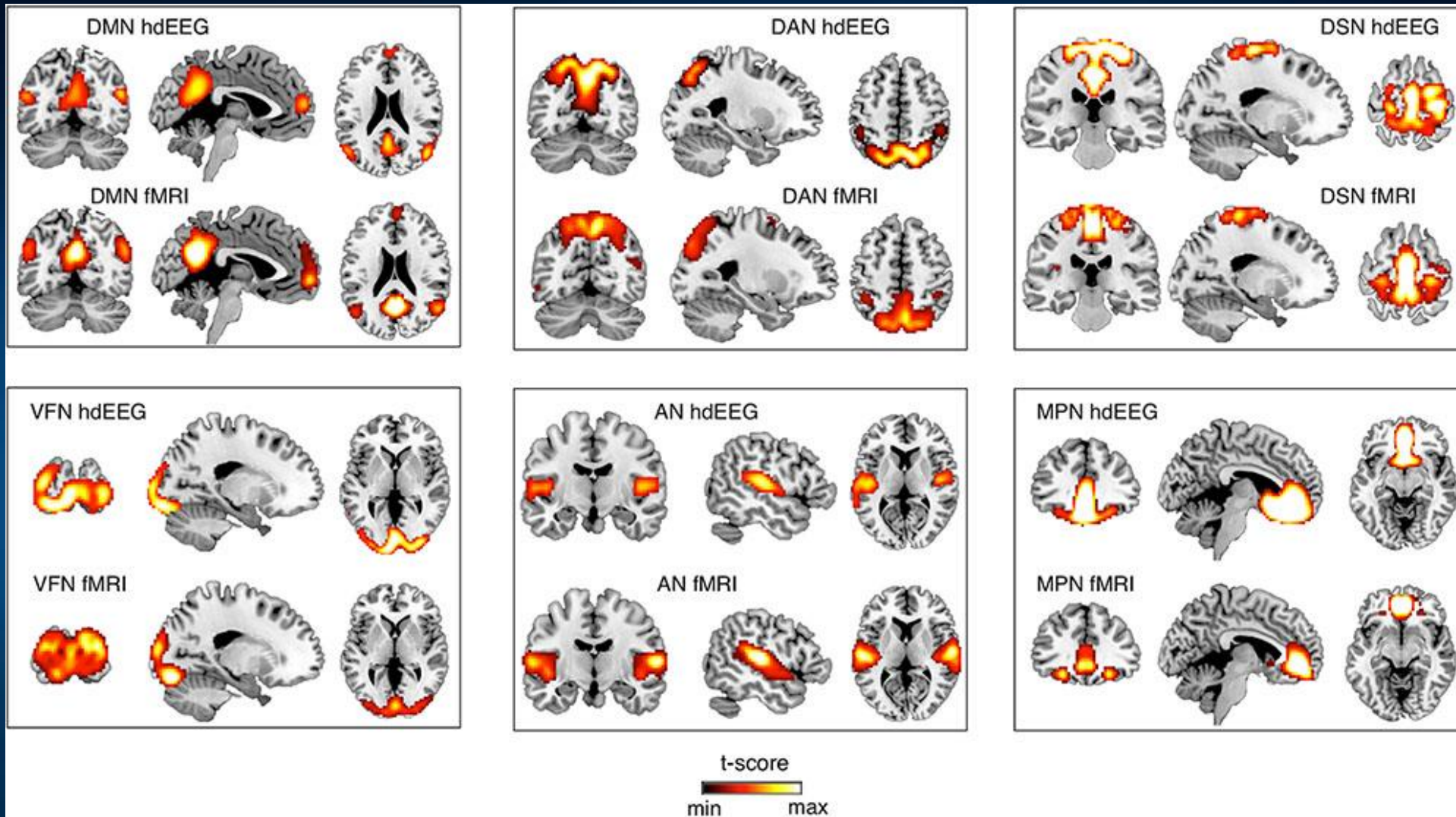

sICA on 10-min fMRI data ($N = 24$, threshold: $p < 0.01$, TFCE corrected). DMN, default mode network; DAN, dorsal attention network; DSN, dorsal somatomotor network; VFN, visual foveal network; AN, auditory network; MPN, medial prefrontal network.

EEG-RSN maps obtained using spatial ICA

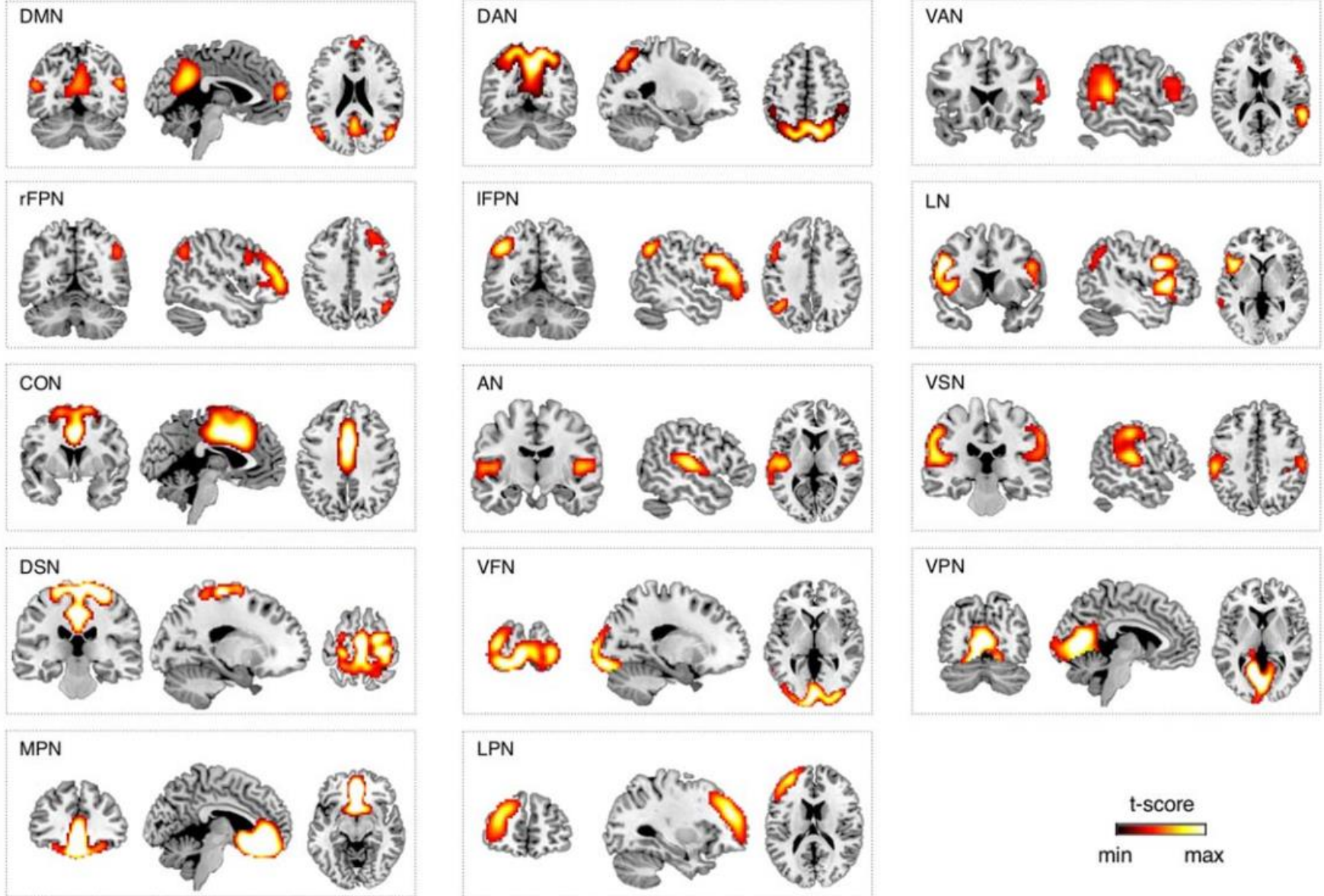

From Two-way to Multi-way Analysis Integration and Fusion of Various Modalities EEG+fNIRS +fMRI

A. Cichocki Lab
RIKEN Brain Science Inst.

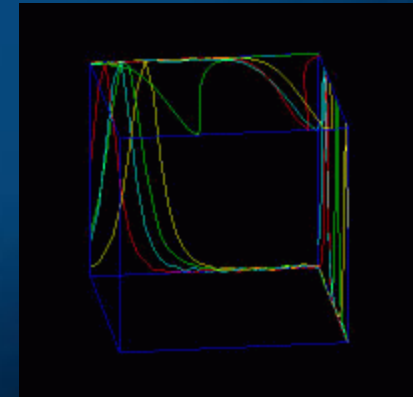
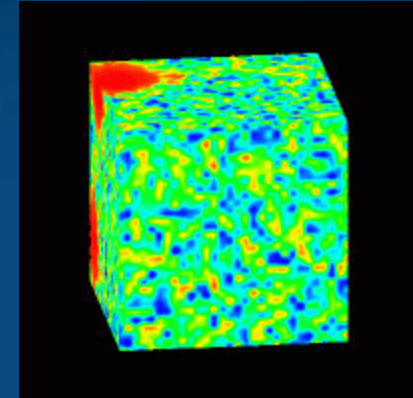
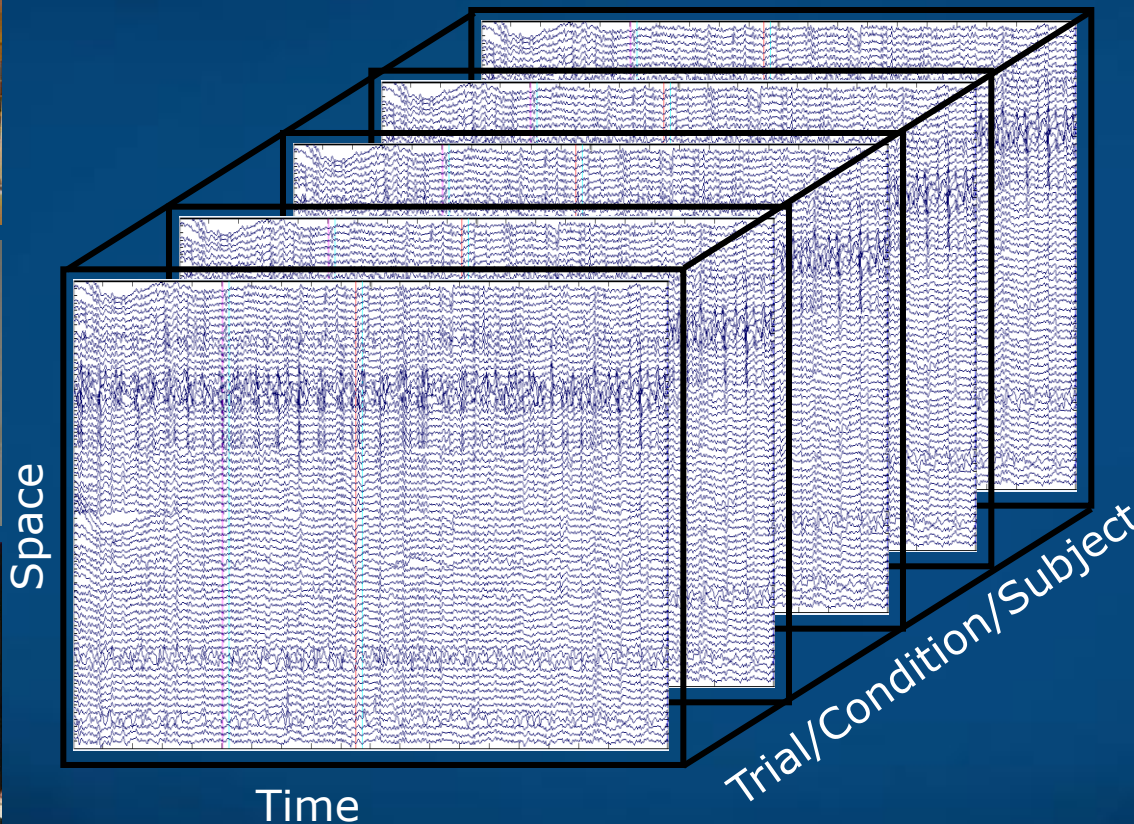

Exploratory and multi-way blind source separation and tensor factorizations: unsupervised learning methods and software to find the hidden causes & underlying hidden structure in the data.

Tensorization of Convolutive Deep Learning NN

"Non-deep" feedforward neural network

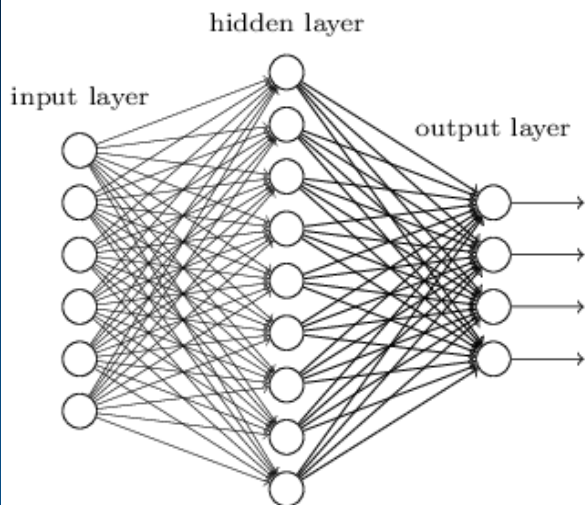

Deep neural network

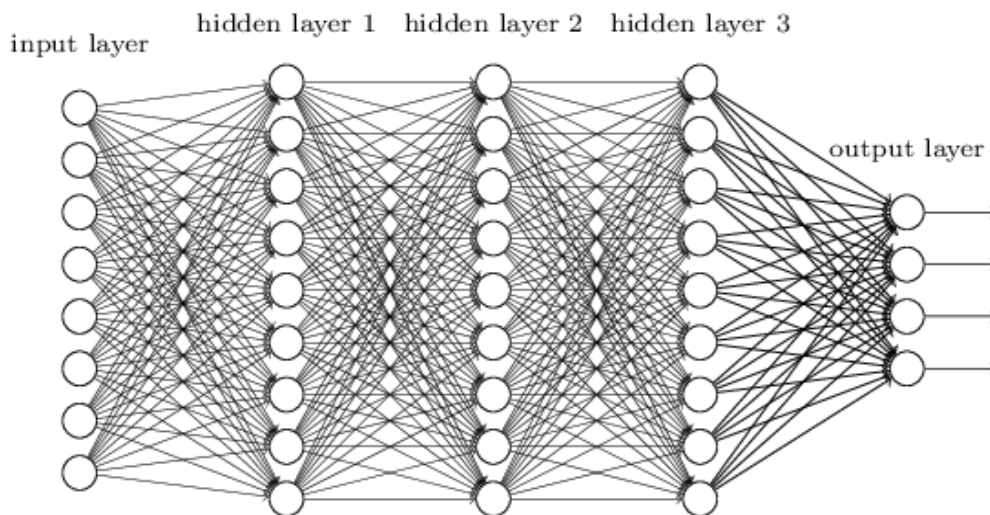

A. Cichocki Lab
RIKEN BSI

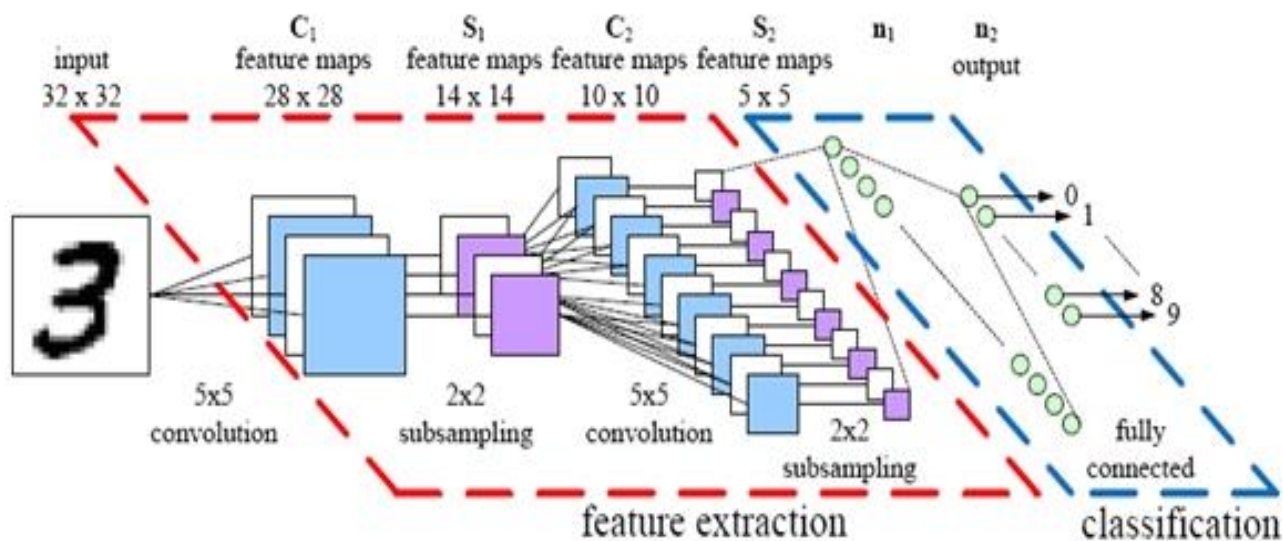

Fingerprints of Mental Activity

Mental images from brain activity

Can we convert activity of the brain into the mental images that we are conscious of?

Try to estimate features at different layers.

8-layer convolution network, ~60 mln parameters, feature vectors from randomly selected 1000 units in each layer to simplify calculations.

Output: 1000 images.

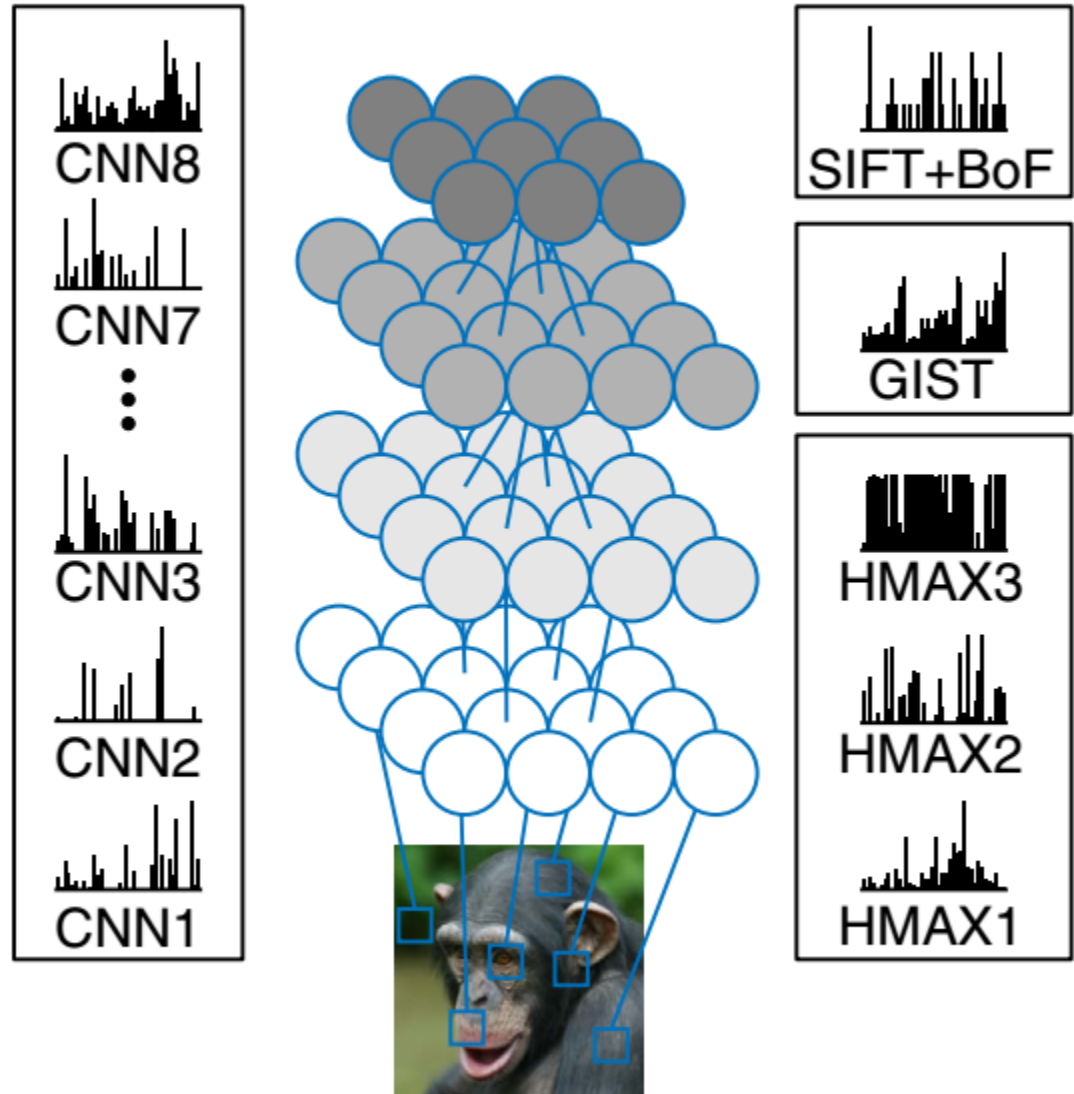

Brain activity \leftrightarrow Mental image

fMRI activity can be correlated with deep CNN network features; using these features closest image from large database is selected. Horikawa, Kamitani, Generic decoding of seen and imagined objects using hierarchical visual features. Nature Comm. 2017.

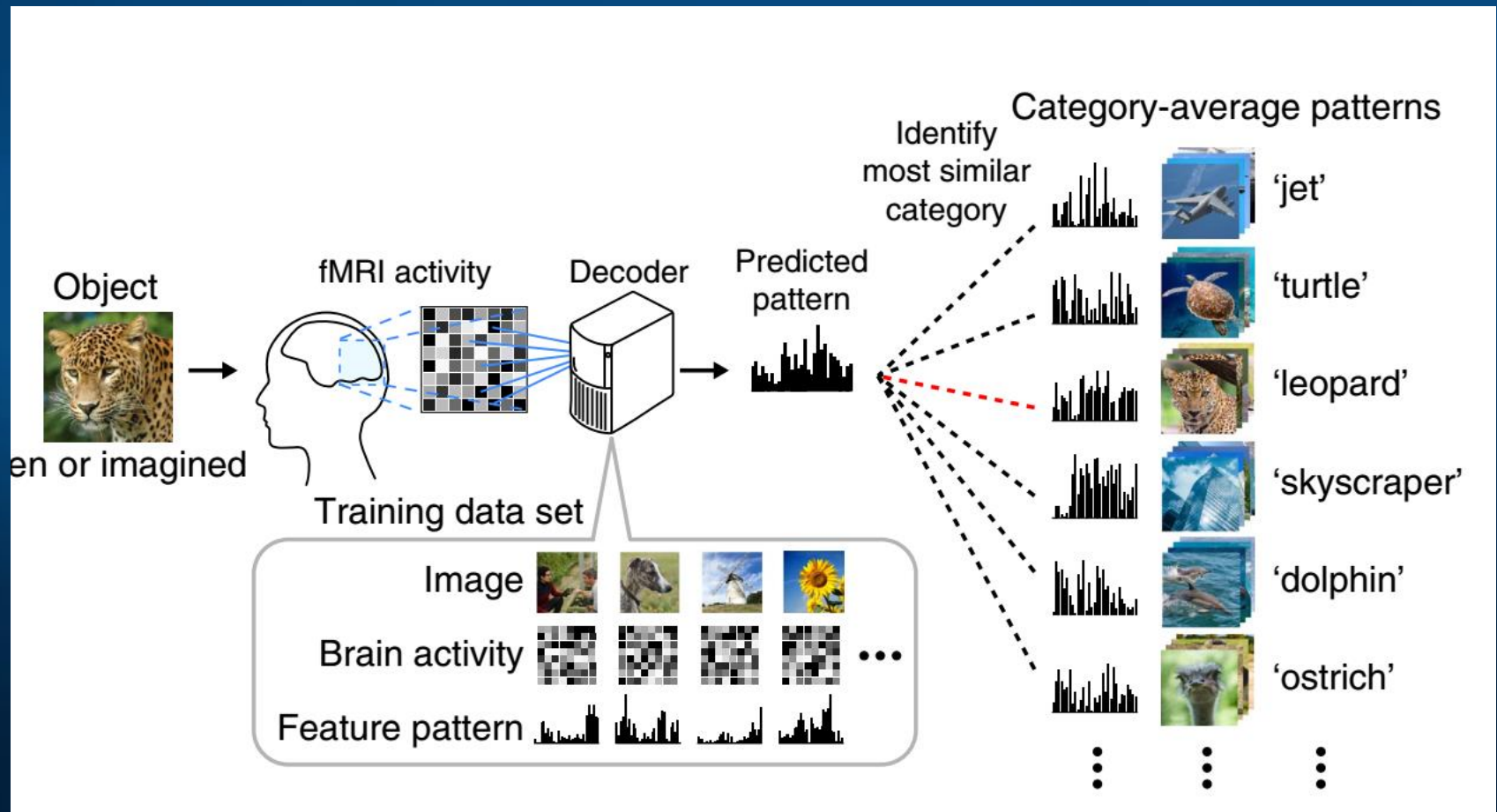

Decoding Dreams



Decoding Dreams, ATR Kyoto, Kamitani Lab. fMRI images analysed during REM phase or while falling asleep allows for dream categorisation.

Dreams, thoughts ... can one hide what has been seen and experienced?

Neural screen

Features are discovered, and their combination remembered as face, but detailed recognition needs detailed recording from neurons – 205 neurons in various visual areas used.

L. Chang and D.Y. Tsao, “The code for facial identity in the primate brain,” *Cell* 2017

DARPA (2016): put million nanowires in the brain! Use them to read neural responses and 10% of them to activate neurons.

1. We recorded patches

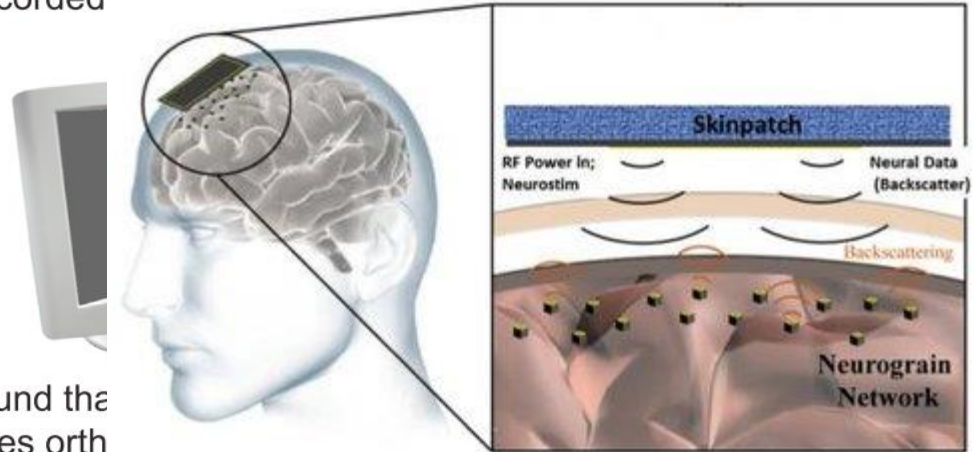

2. We found the to changes orth

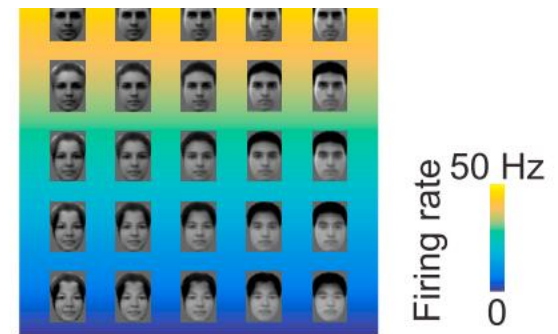
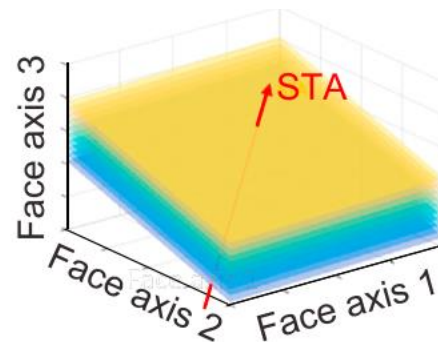

3. We found that an axis model allows precise encoding and decoding of neural responses

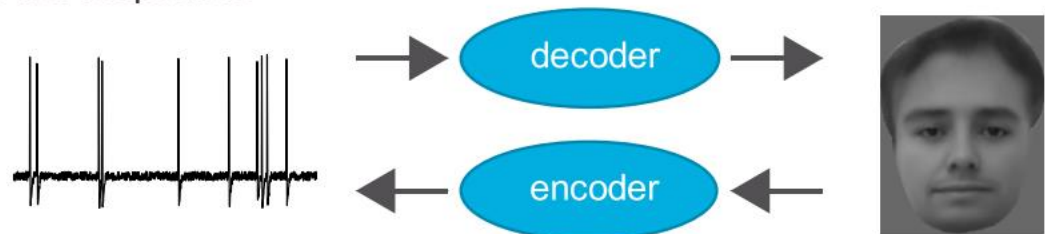

Mental images

Facial identity is encoded via a simple neural code that relies on the ability of neurons to distinguish facial features along specific axes in the face space.

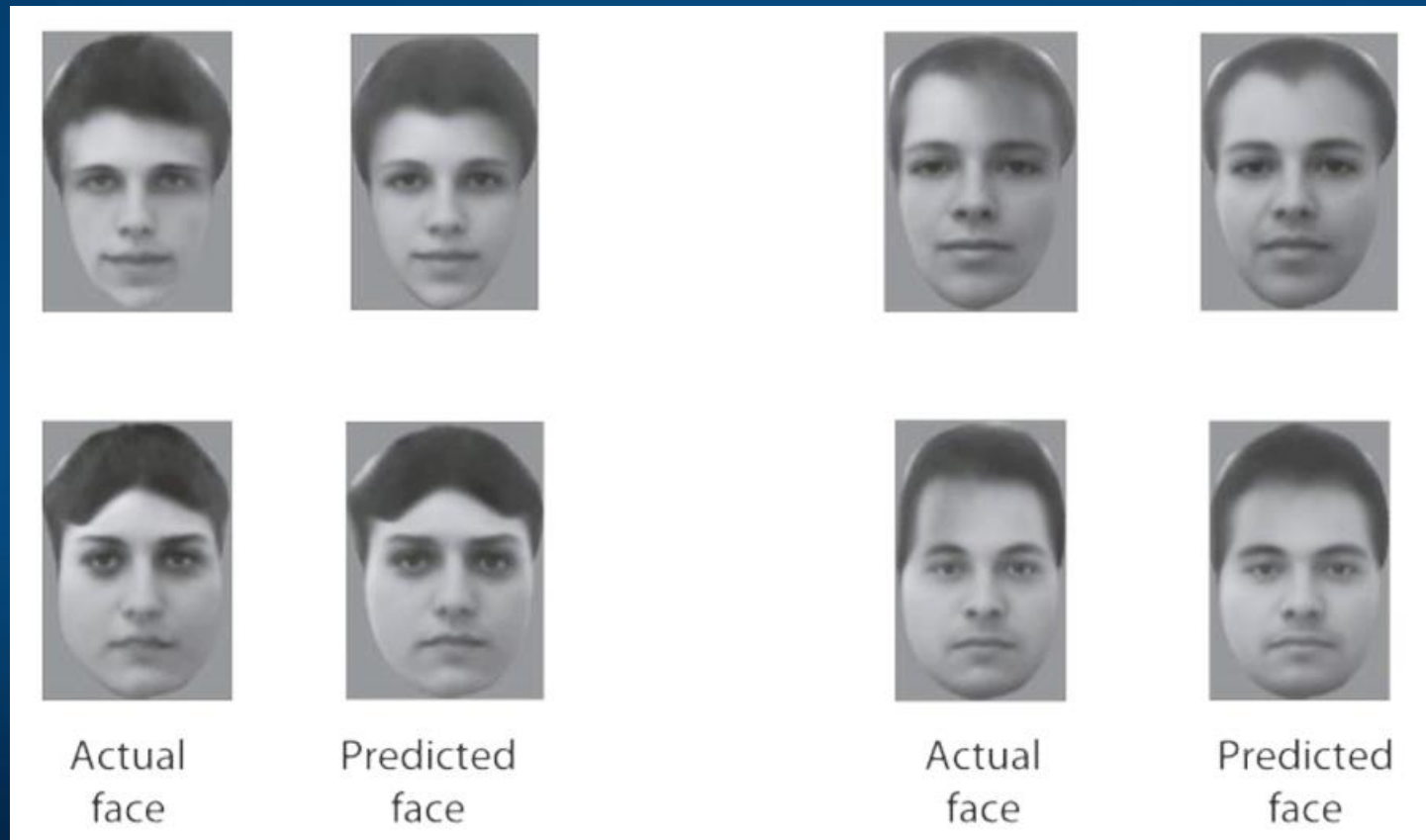

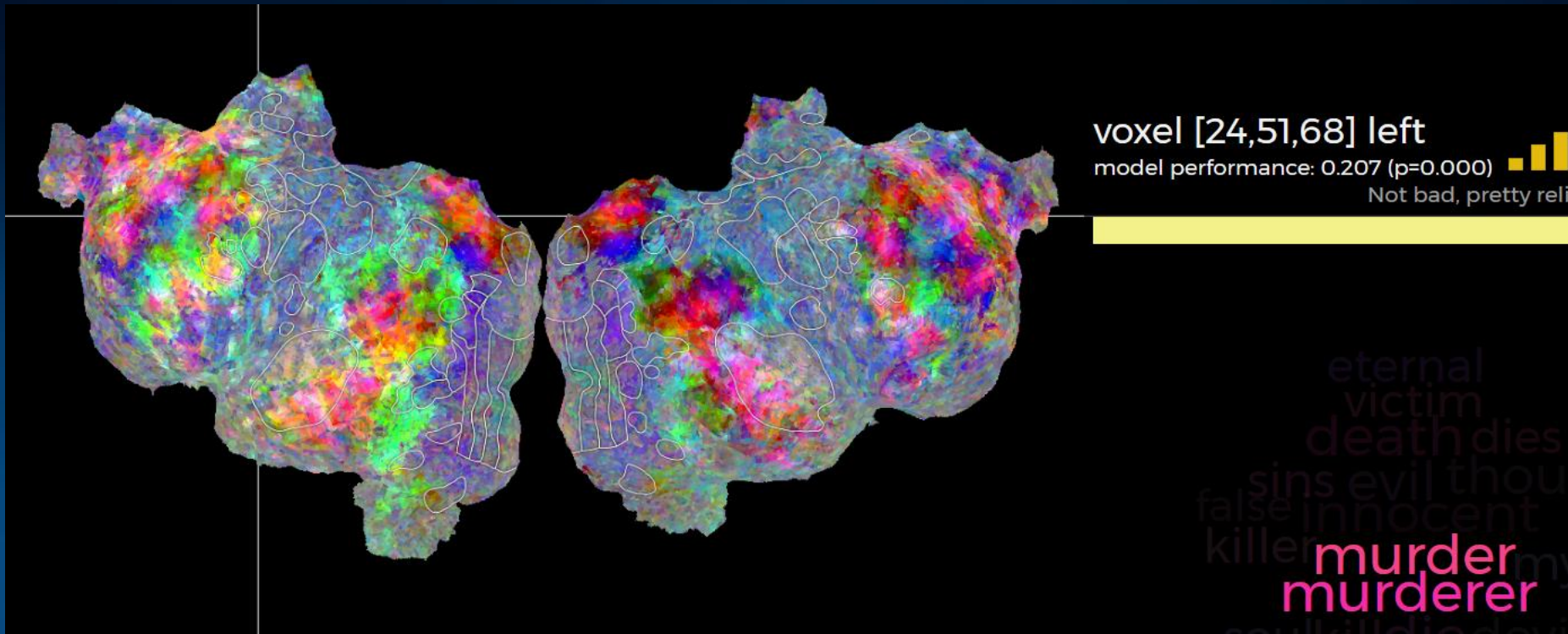

Whole fMRI activity map for the word “murder” shown on the flattened cortex.

Each word activates a whole map of activity in the brain, depending on sensory features, motor actions and affective components associated with this word.

Why such activity patterns arise? Brain subnetworks connect active areas.

<http://gallantlab.org/huth2016/> and [short movie intro](#).

Can one do something like that with EEG or MEG?

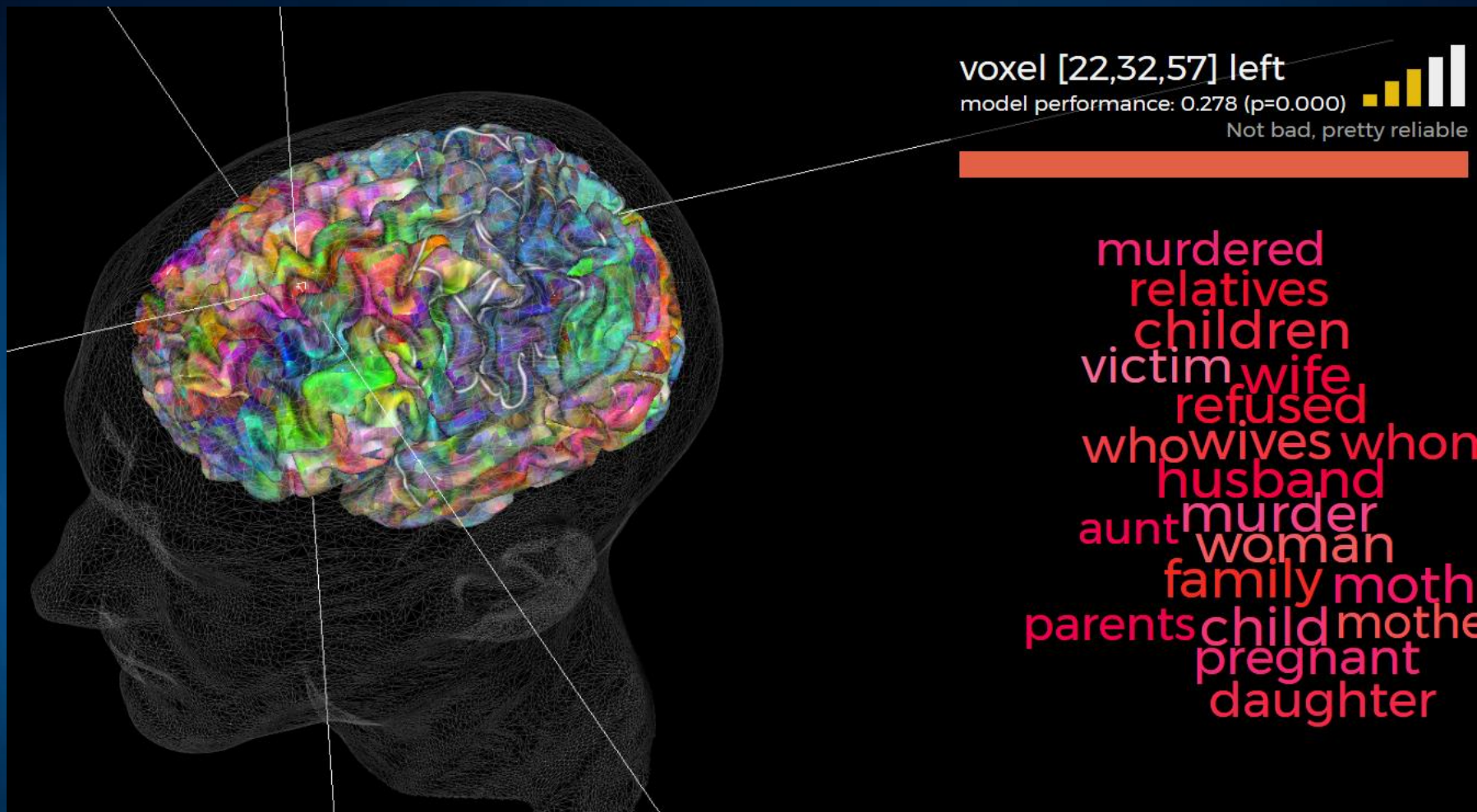

Each voxel responds usually to many related words, whole categories.

<http://gallantlab.org/huth2016/>

Huth et al. (2016). Decoding the Semantic Content of Natural Movies from Human Brain Activity. *Frontiers in Systems Neuroscience* 10, pp. 81

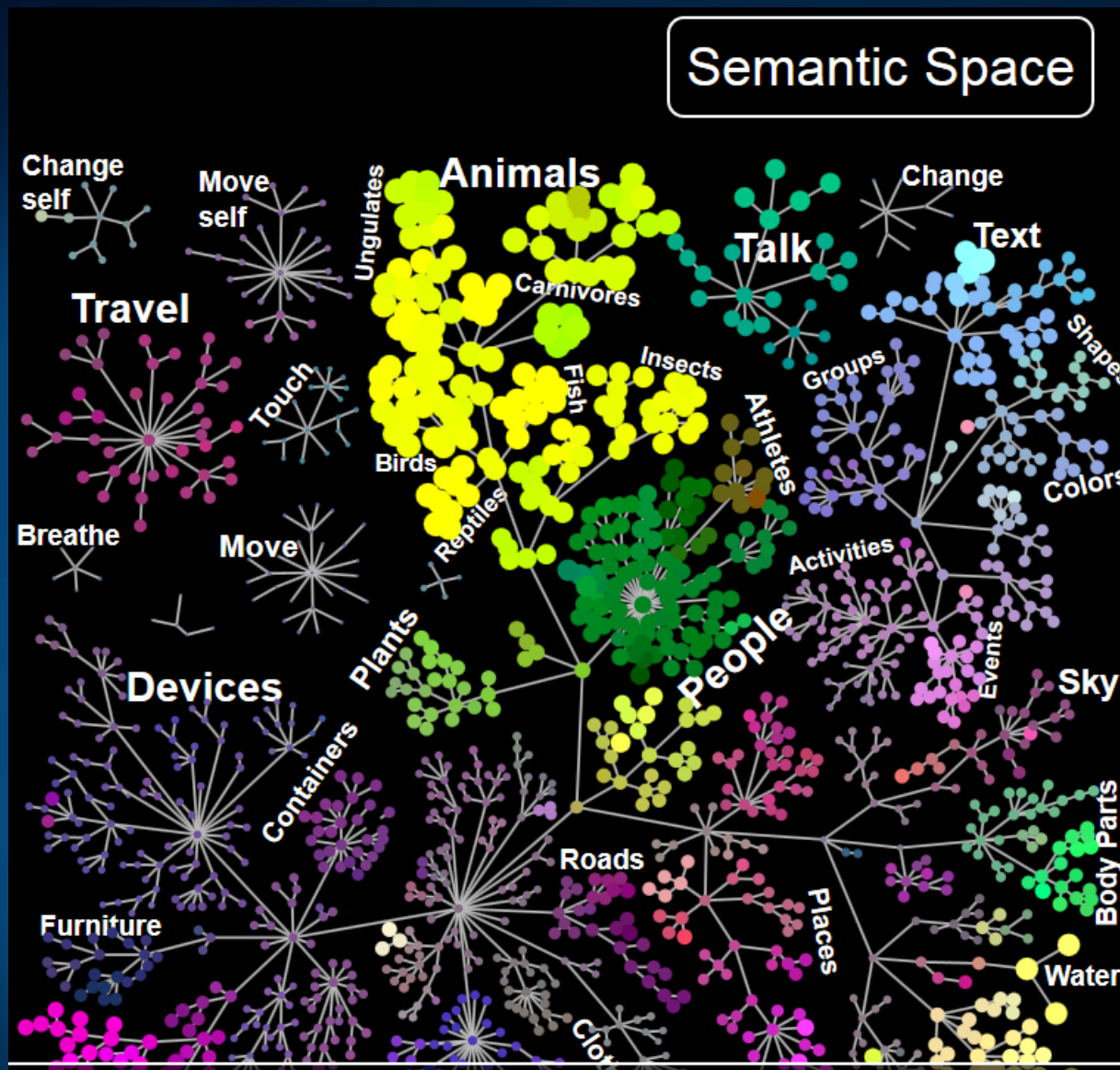

Words in the semantic space are grouped by their similarity (Gallant Lab, 2016). Words activate specific ROIs, similar words create similar maps of brain activity. Each voxel may be activated by many words. Video or audio stimuli, fMRI scans.

Narration

Nicole Speer et al.
 Reading Stories Activates Neural
 Repre-sentations of Visual and
 Motor Experiences. *Psychological
 Science* 2009; 20(8): 989–999.

Thought: spatiotemporal pattern

Meaning: always slightly
 different, depending on the
 context, but still may be clustered
 into relatively small number of
 distinct meanings.

Sentences: trajectories in
 semantic space, building scenes,
 mind models with characters,
 objects, spatio-temporal
 relations.

A

Clause	Cause	Character	Goal	Object	Space	Time
...[Mrs. Birch] went through the front door into the kitchen.	●				●	
Mr. Birch came in	●	●			●	
and, after a friendly greeting,	●					●
chatted with her for a minute or so.	●					●
Mrs. Birch needed to awaken Raymond.		●				
Mrs. Birch stepped into Raymond's bedroom, pulled a light cord hanging from the center of the room,			●		●	
and turned to the bed.						
Mrs. Birch said with pleasant casualness, "Raymond, wake up."						
With a little more urgency in her voice she spoke again:						
Son, are you going to school today?						
Raymond didn't respond immediately.		●				●
He screwed up his face			●			
And whimpered a little.						

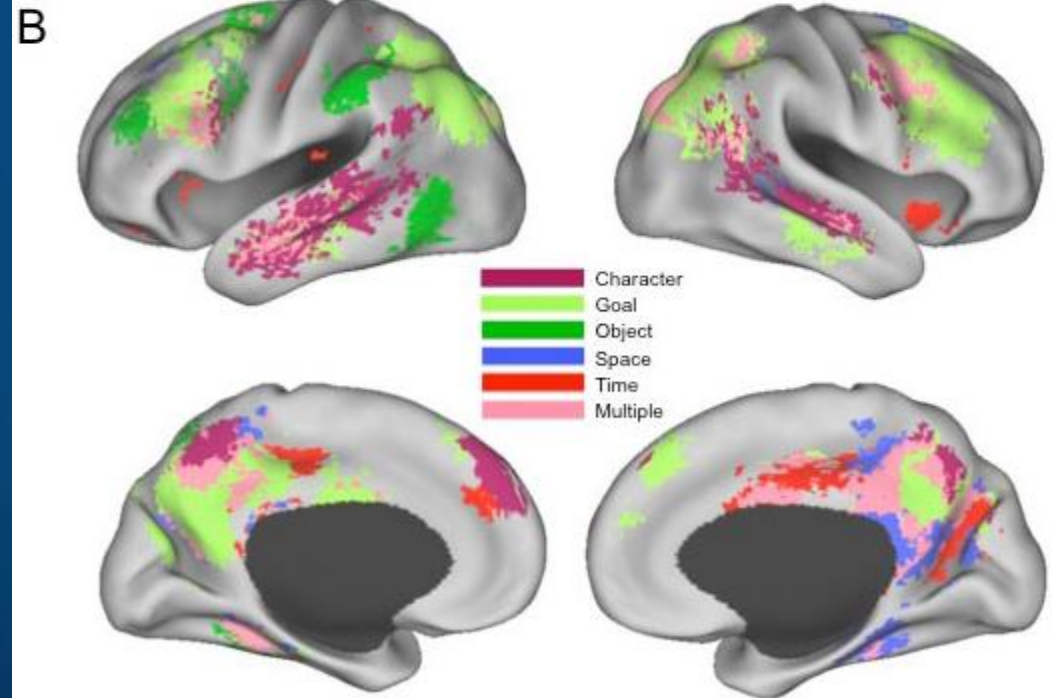

Dynamic functional brain networks

Questions

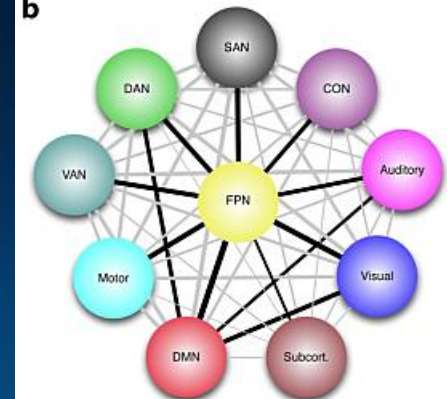

Global Neuronal Workspace Theory (Dehaene et al. 1998): brain processes underlying effortful tasks require two main computational spaces:

- a set of specialized and modular perceptual, motor, memory, evaluative, and attentional processors;
- a unique global workspace composed of distributed and heavily interconnected neurons with long-range axons.

Workspace neurons are mobilized in effortful tasks for which the specialized processors (Kahneman's System 1) do not suffice (System 2), mobilize or suppress contribution of specific processor neurons.

1. Can the whole-brain network properties change during performance?
2. Do modularity, path length, global, local efficiency and other network measures dependent on the cognitive load?

Finc, K., Bonna, K., Lewandowska, M., Wolak, T., Nikadon, J., Dreszer, J., Duch W, Kühn, S. (2017). Transition of the functional brain network related to increasing cognitive demands. *Human Brain Mapping*, 38(7), 3659–3674.

Cognitive load on whole-brain network

35 participants (17 females; Mean age = 22.6 ± 3.1 ; 19-31).

Letter *n*-back task

Low cognitive effort

High cognitive effort

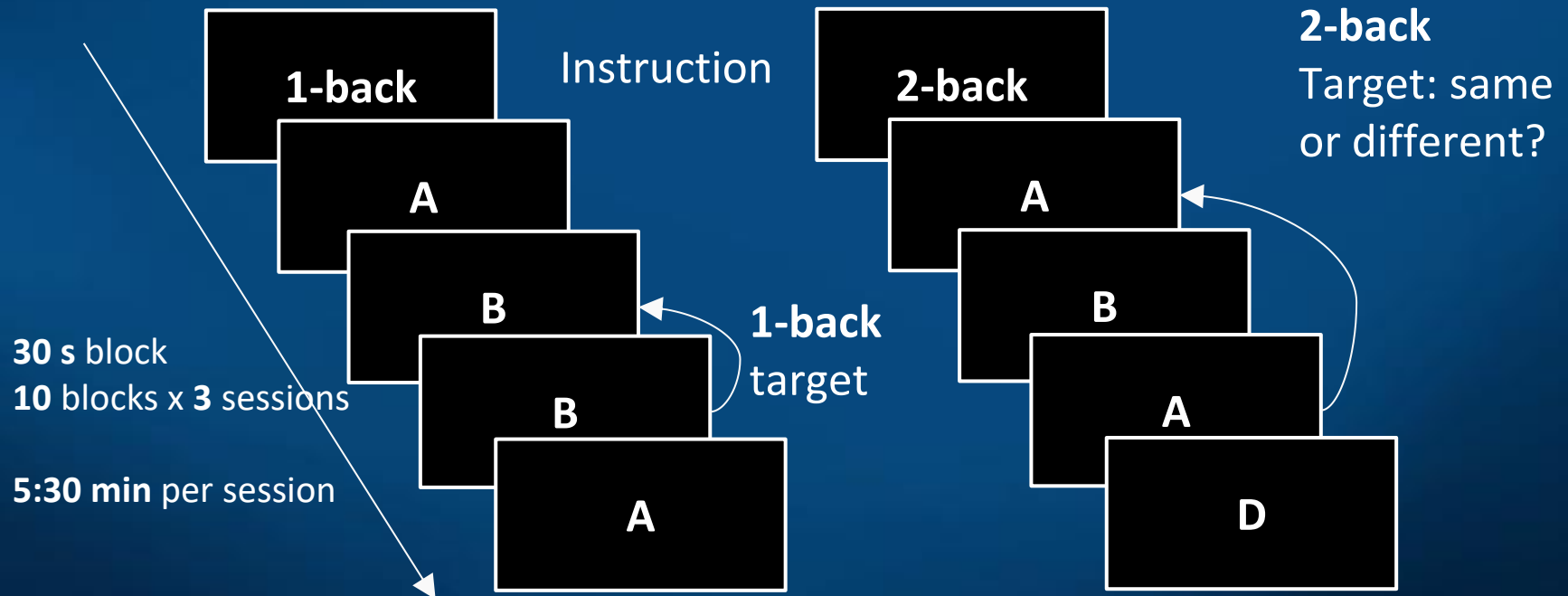

Data workflow

Two experimental conditions: 1-back, 2-back

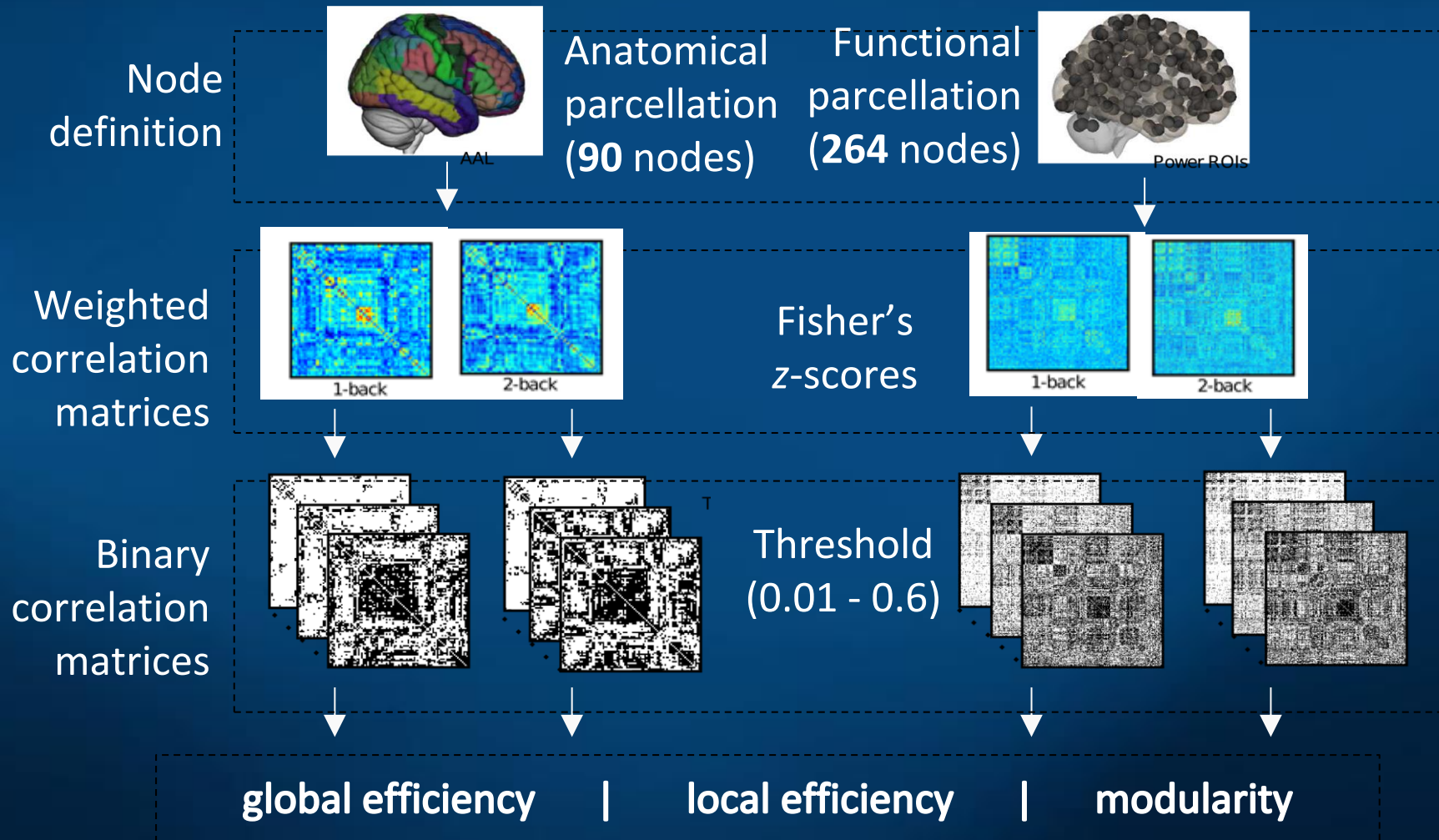

Brain modules and cognitive processes

Simple and more difficult tasks, requiring the whole-brain network reorganization.

Left: 1-back

Right: 2-back

Average over 35 participants.

Left and midline sections.

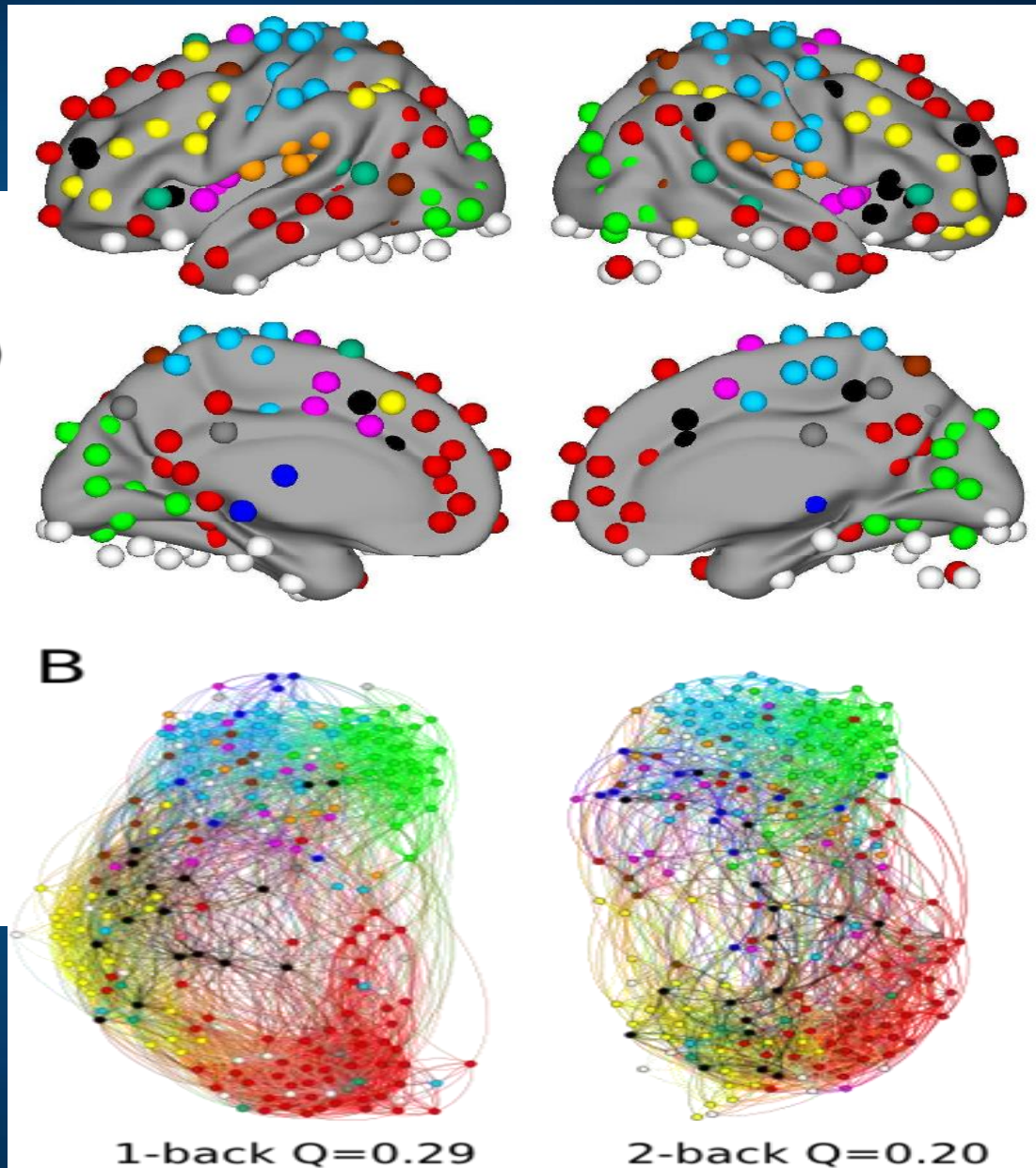
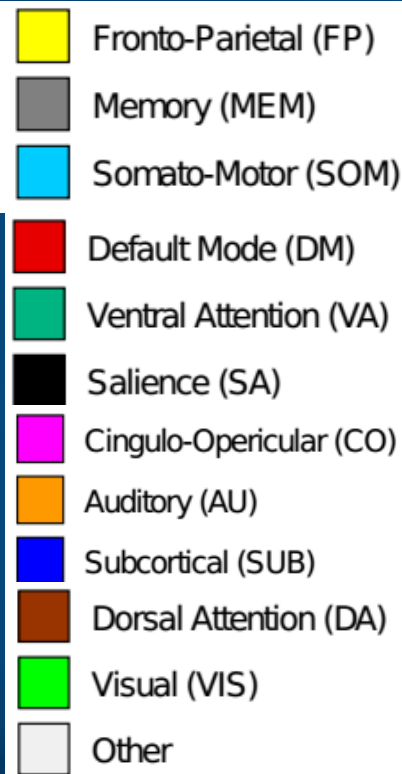

K. Finc et al, HBM (2017).

Brain modules and cognitive processes

Simple and more difficult tasks, requiring the whole-brain network reorganization.

Left: 1-back local hubs

Right: 2-back local hubs

Average over 35 *participants*.

Dynamical change of the landscape of attractors, depending on the cognitive load.

Less local (especially in DMN), more global binding (especially in PFC).

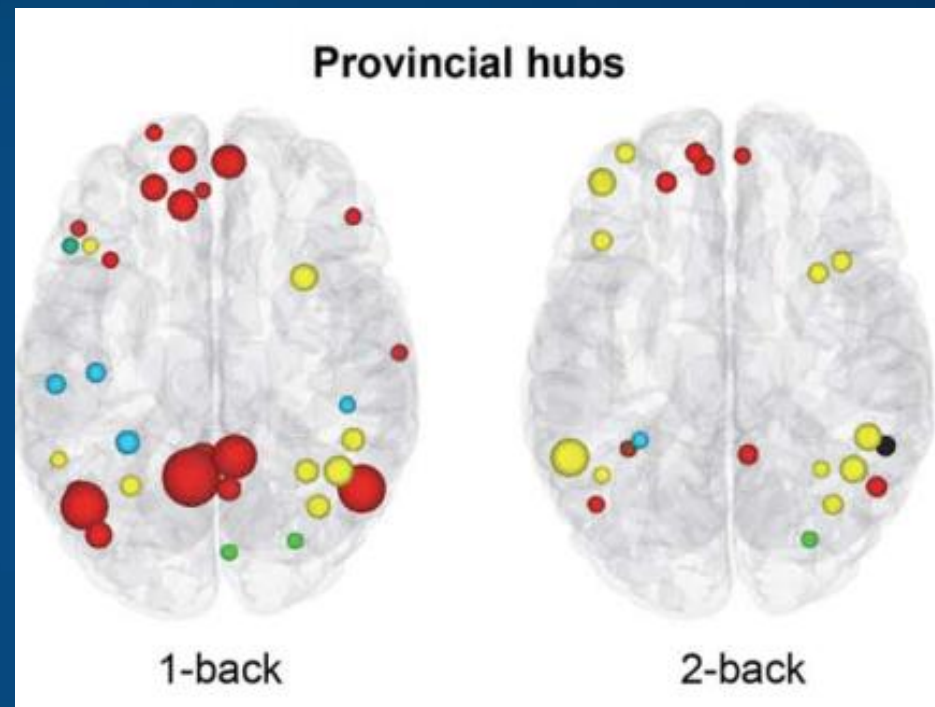

K. Finc et al, HBM (2017).

Brain modules and cognitive processes

Simple and more difficult tasks, requiring the whole-brain network reorganization.

Left: 1-back connector hubs

Right: 2-back connector hubs

Average over 35 *participants*.

Dynamical change of the landscape of attractors, depending on the cognitive load – System 2 (Khaneman).

DMN areas engaged in global binding!

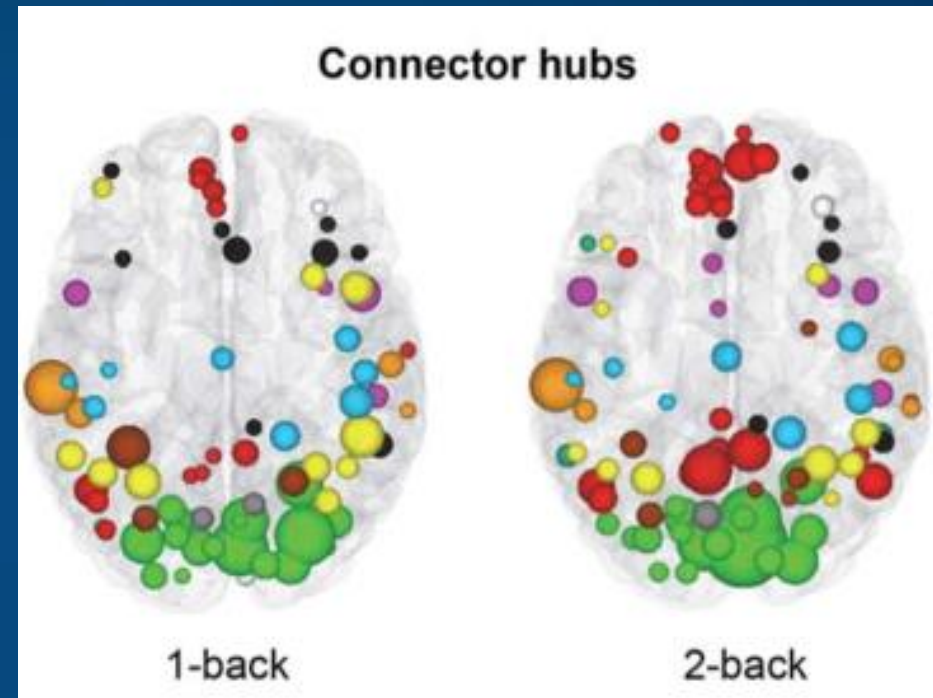

K. Finc et al, HBM (2017).

Changes in modularity

Modularity metric: fraction of within-community edges in the network minus such fraction for randomly connected network with unchanged community structure.



Parcellation
AAL, 90 ROI



Parcellation
264 ROI
functional

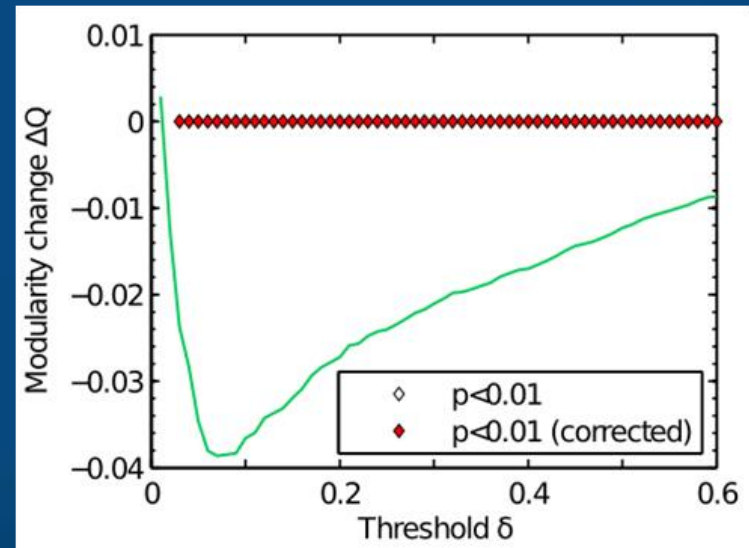
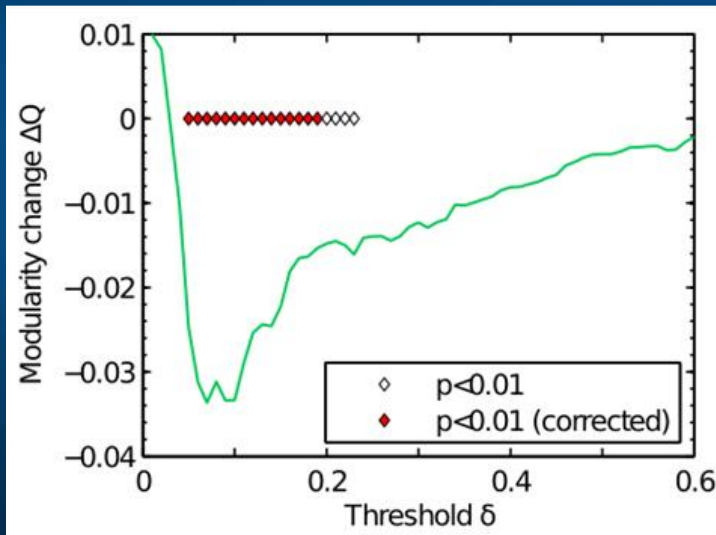

Modularity for both parcellations significantly decreases for thresholds ~ 0.1 .
Coarse parcellation washes out many effects, especially strong correlations.

Changes in efficiency

Global efficiency \sim inverse of characteristic path length

Local efficiency \sim clustering coefficient (Latora & Marchiori, 2001).



AAL

Parcellation
AAL, 90 ROI



Power ROIs

Parcellation
264 ROI
functional

Global efficiency

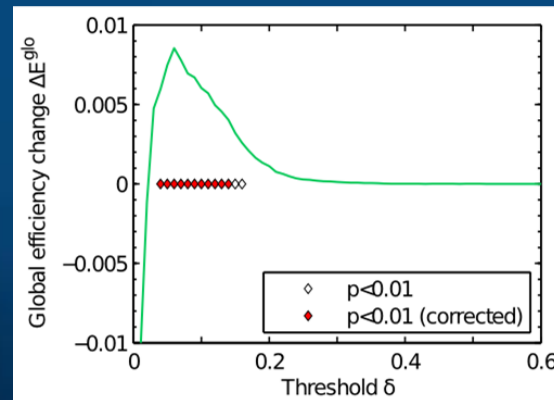
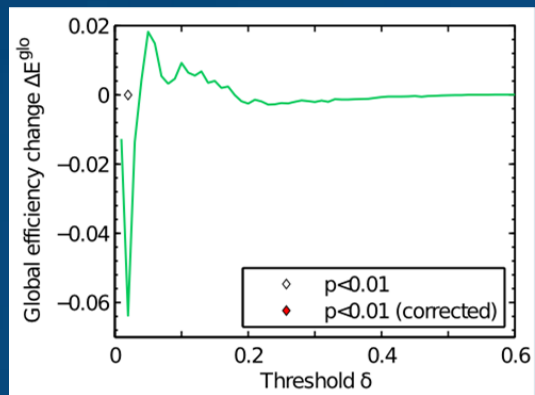

Local efficiency

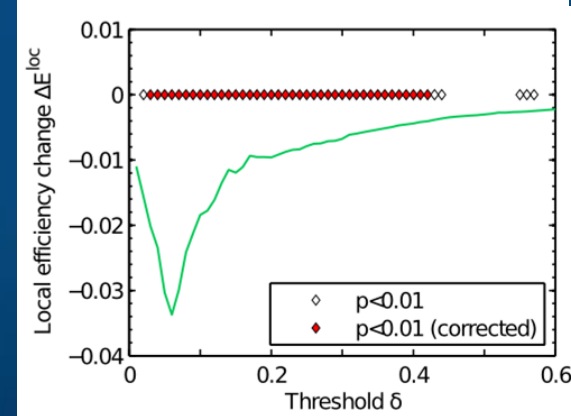
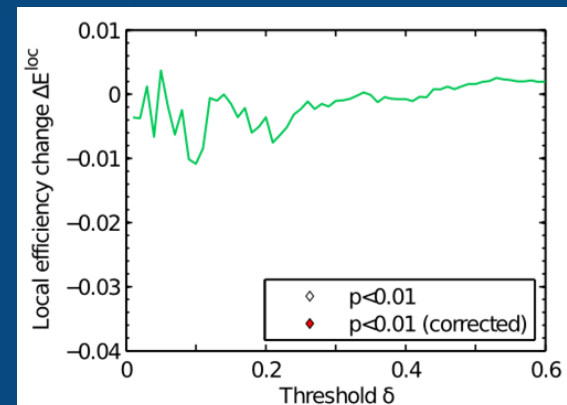

Cognitive load

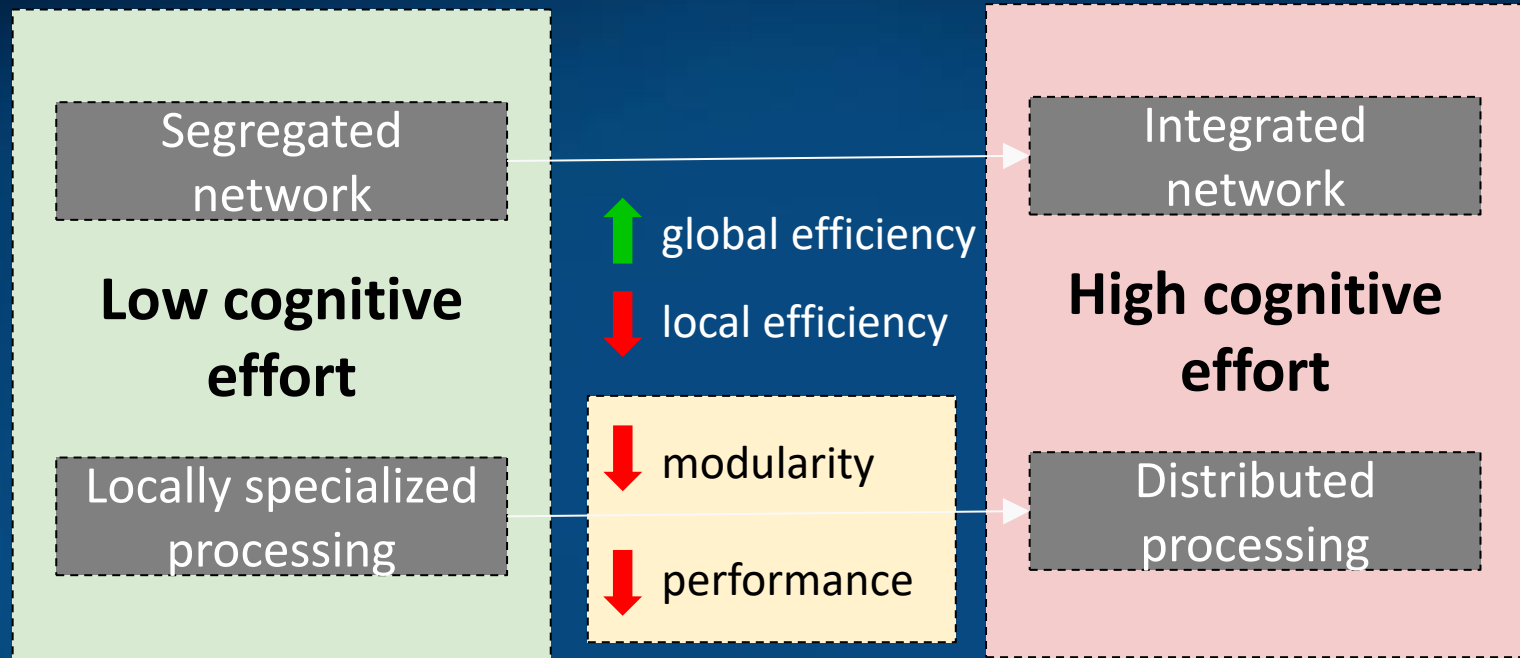

≠



Parcellation into 264 regions (10 mm spheres) shows subnetworks more precisely than for 90 regions; only a small subgroup of neurons in each ROI is strongly correlated.

Resting state/cognitive performance

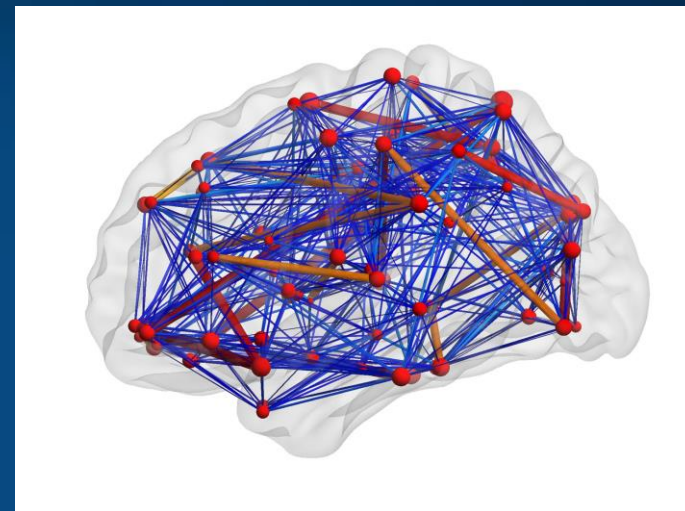
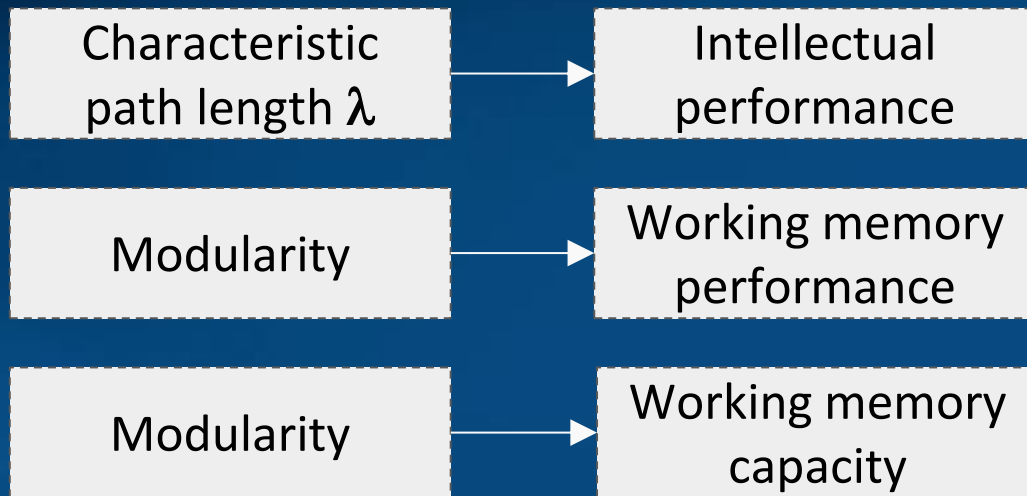

Network modularity \Leftrightarrow higher working memory capacity and performance.

High connectivity within modules and sparse connections between modules increases effective cooperation of brain regions, is associated with higher IQ.

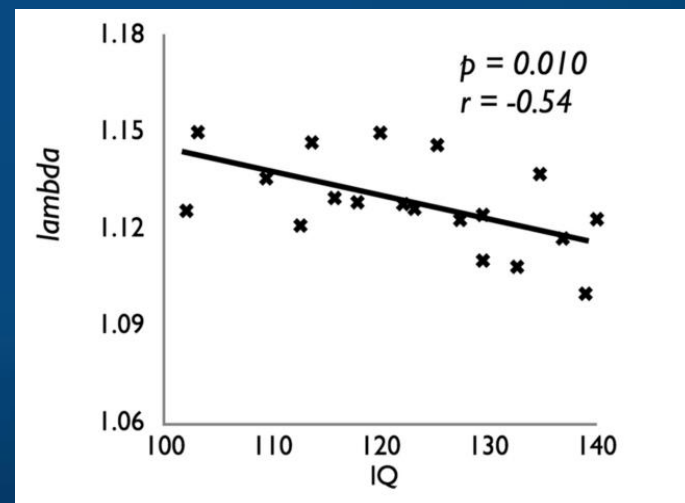

Human Enhancement
and
Optimization of Brain Processes

Neurofeedback: first BCI

Used in clinical practice, α/θ rhythms for relaxation.

Duch, Elektronika i stresy, 1978!

Critical review of existing literature shows that this is not effective.

New forms based on brain fingerprinting needed.

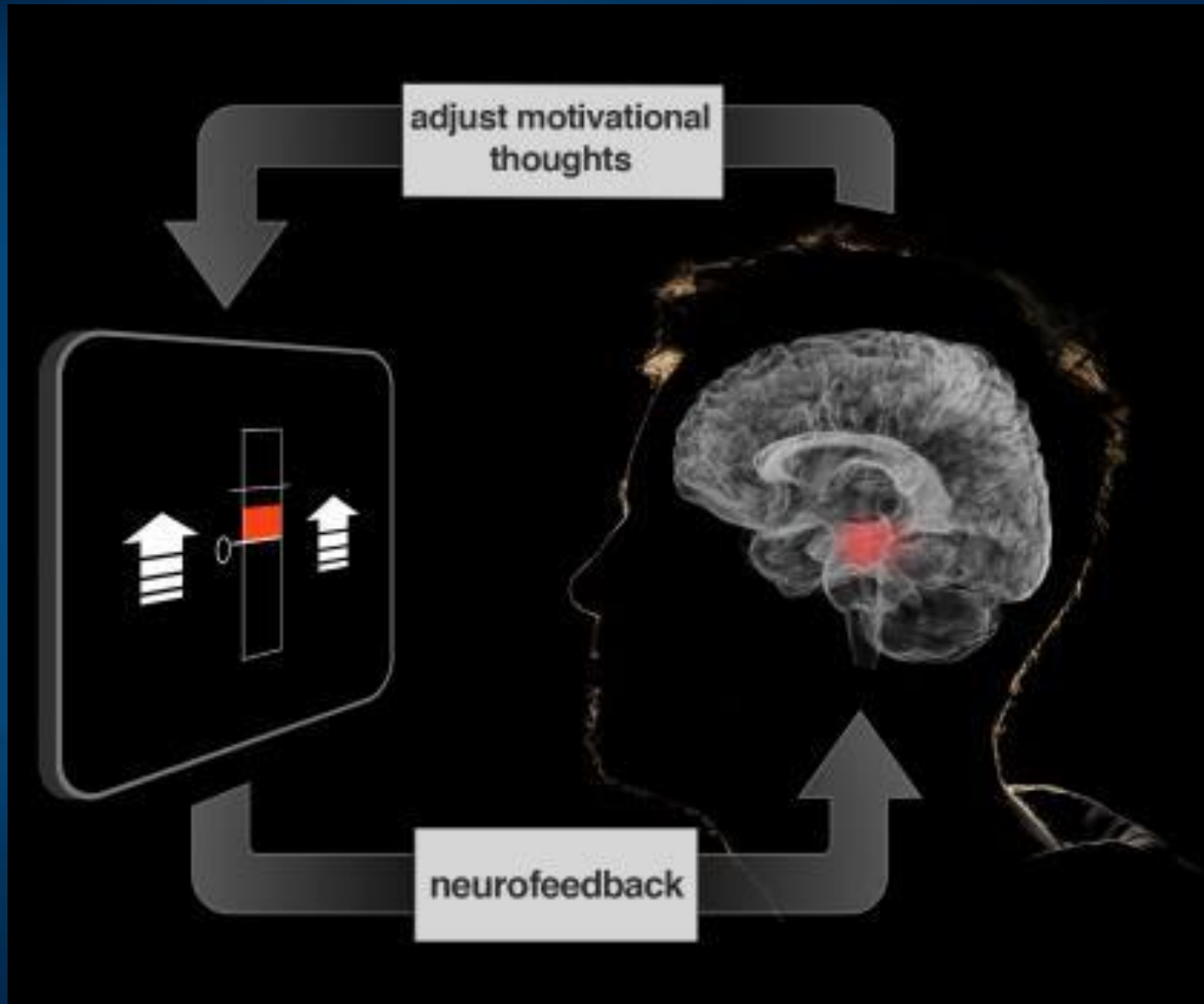

BCI: wire your brain ...

Non-invasive, partially invasive and invasive signals carry progressively more information, but are also harder to implement. EEG is still the king!

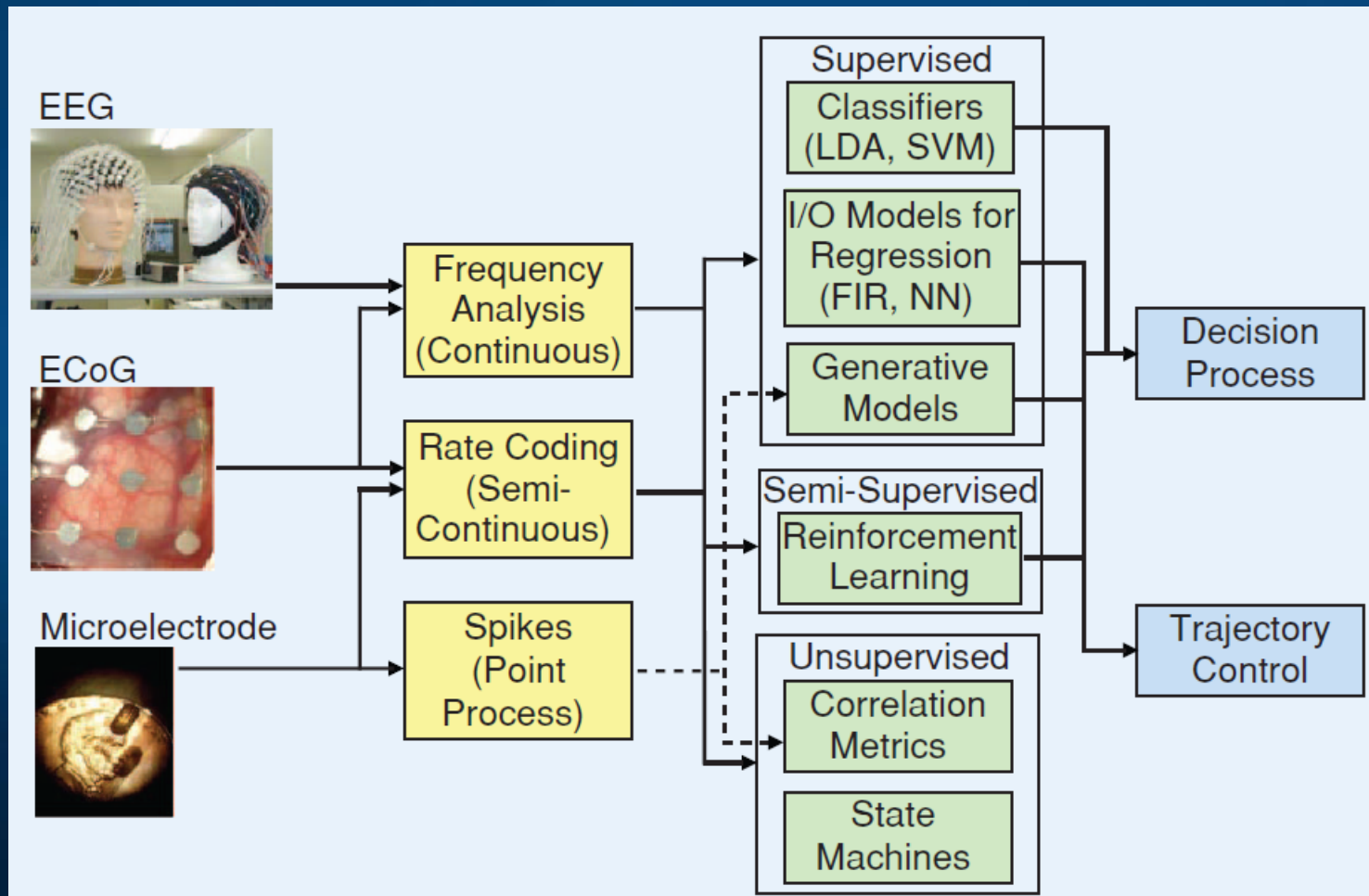

BCI Applications

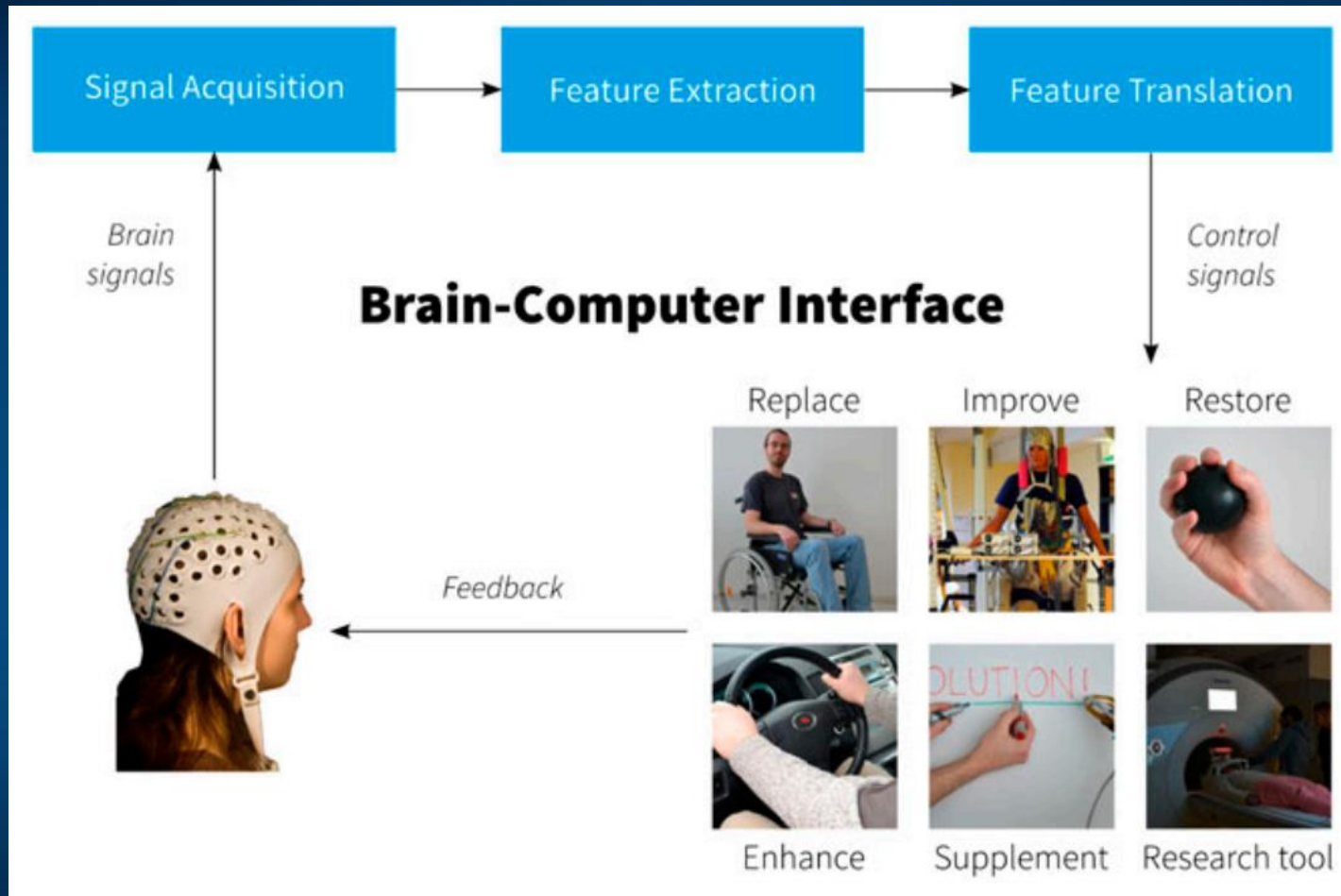

Signals: invasive (brain implants), partially invasive (ECoG), and non-invasive.

Brain-Computer-Brain Interfaces

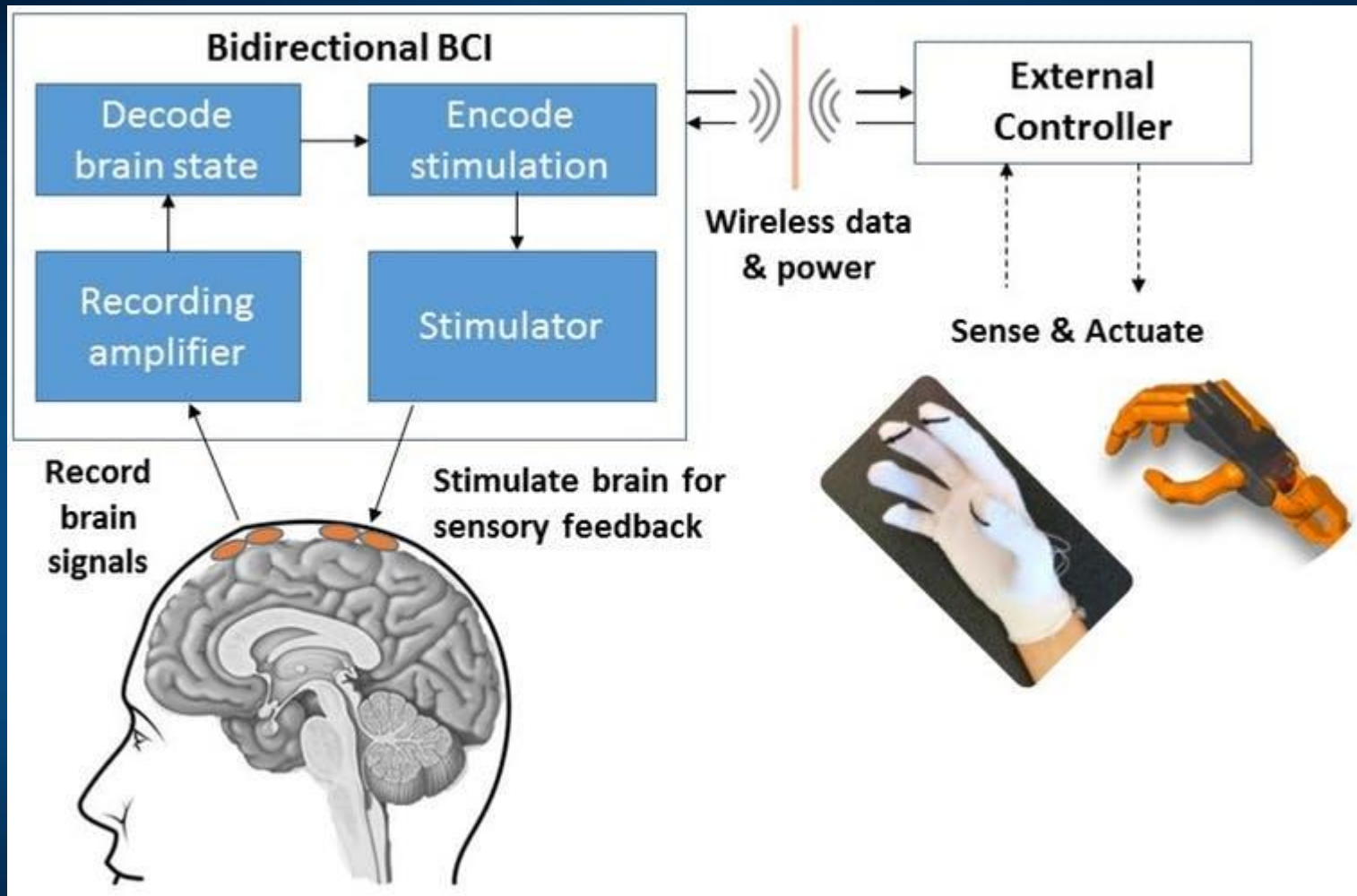

Closed loop system with brain stimulation for self-regulation.
Body may be replaced by sensory signals in Virtual Reality.

Brain stimulation

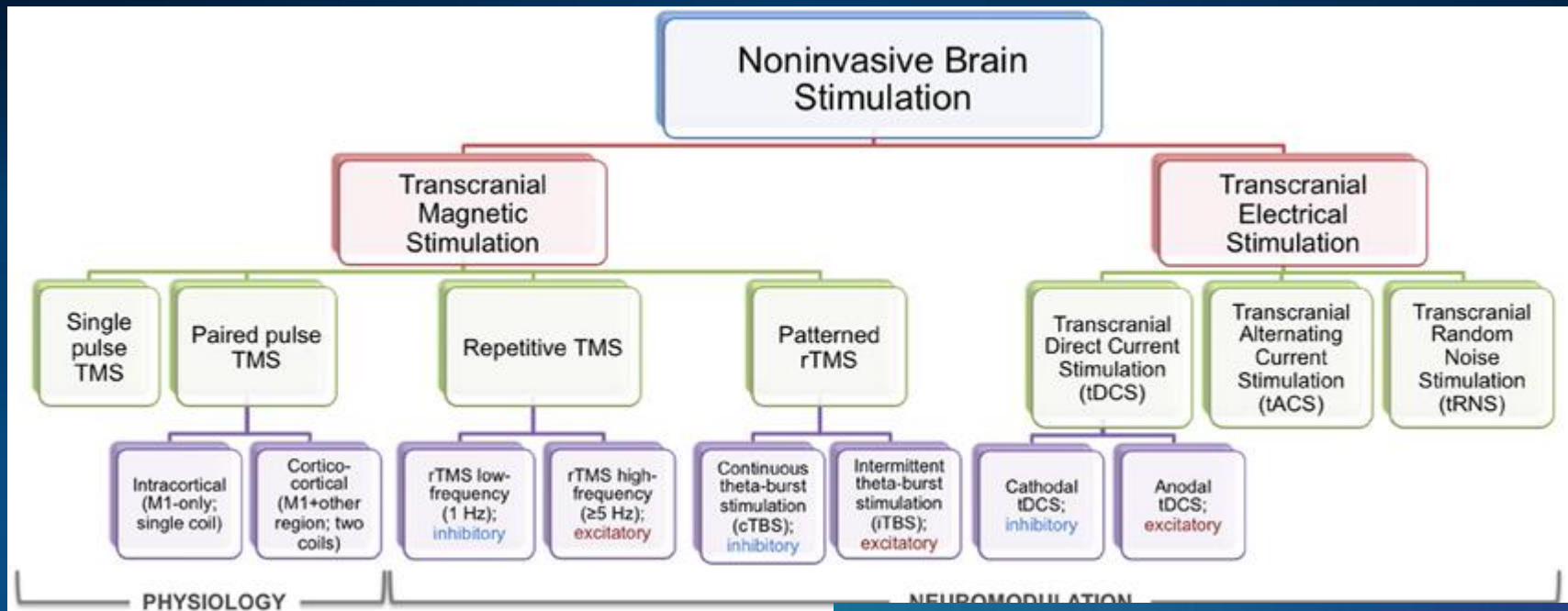

ECT – Electroconvulsive Therapy

VNS – Vagus Nerve Stimulation

Ultrasound, laser ... stimulation.

Complex techniques, but portable phones are also complex.

Attention? Just activate your cortex, no effort is needed!

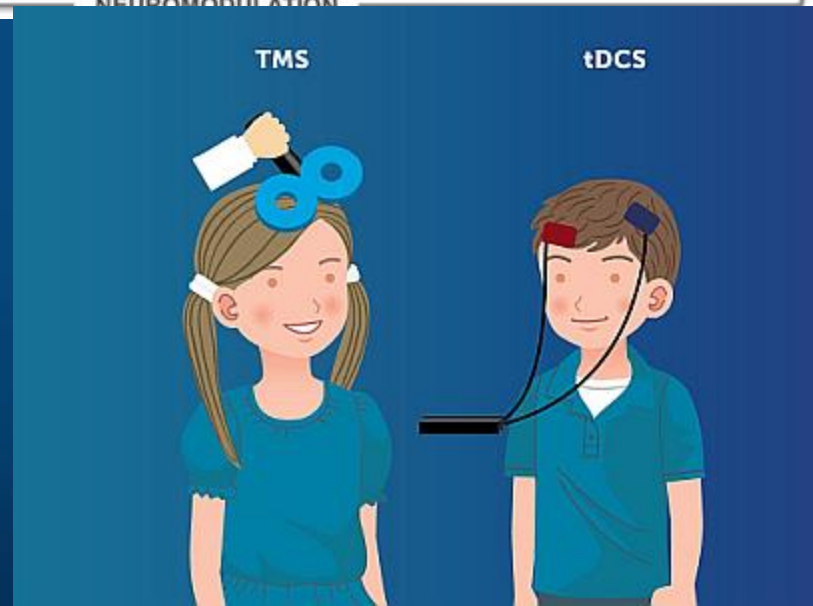

Partially invasive interfaces



Epilepsy, Obsessive-Compulsive Disorder, Phobias ... if you know how to run electric currents through your brain you can control your mental states in a conscious way. New stable electrodes are coming!

Synchronize PFC/PC

Violante, I.R. et al. Externally induced frontoparietal synchronization modulates network dynamics and enhances working memory performance. *ELife*, 6 (2017).

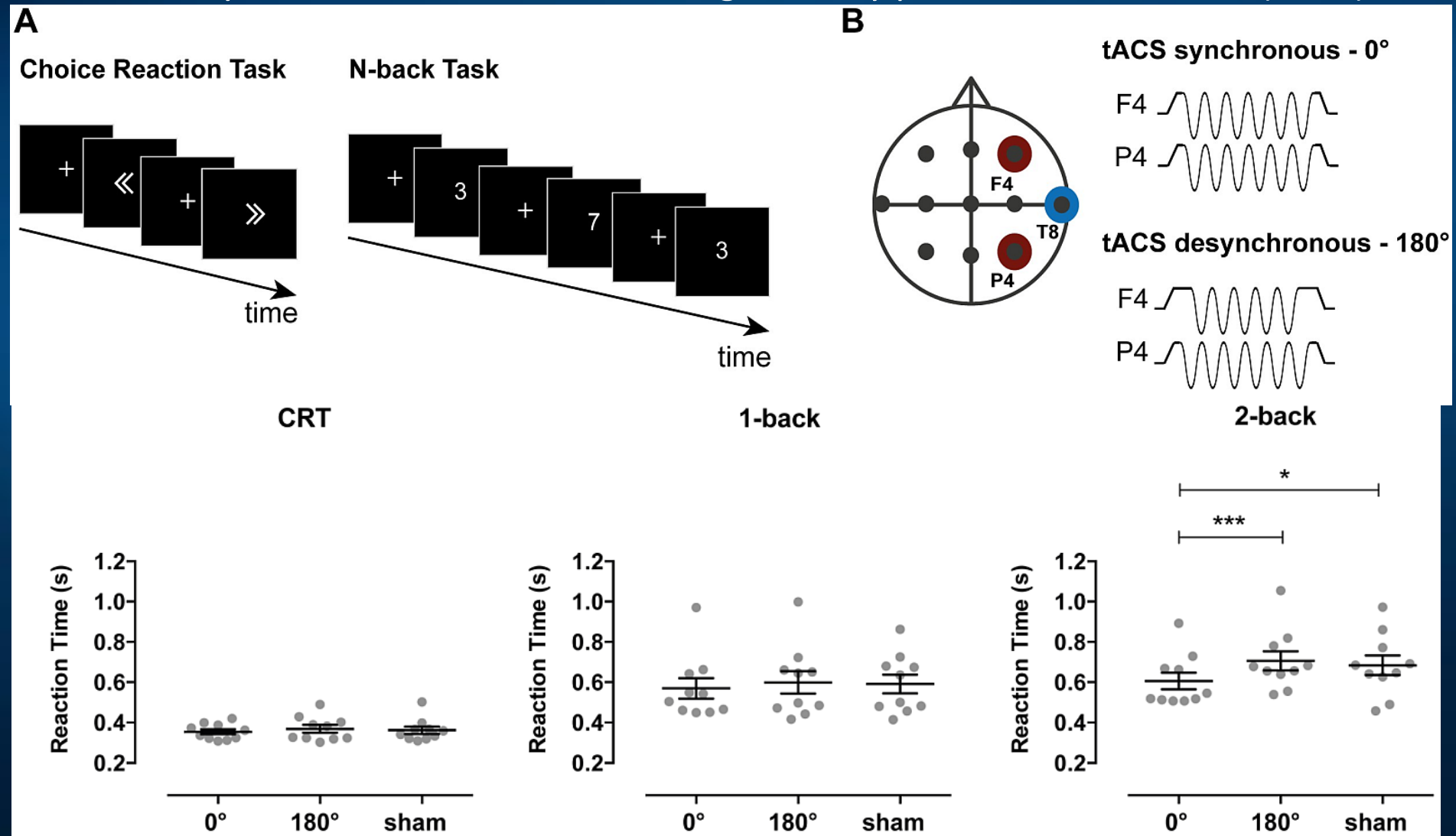

HD EEG/DCS?



EEG electrodes + DCS.

Reading brain states

=> transforming to
common space

=> duplicating in other
brains ...

Depression, neuro-
plasticity, pain,
psychosomatic
disorders, teaching!

Multielectrode DCS
stimulation with 256
electrodes induces
changes in the brain
increasing neuroplasticity.

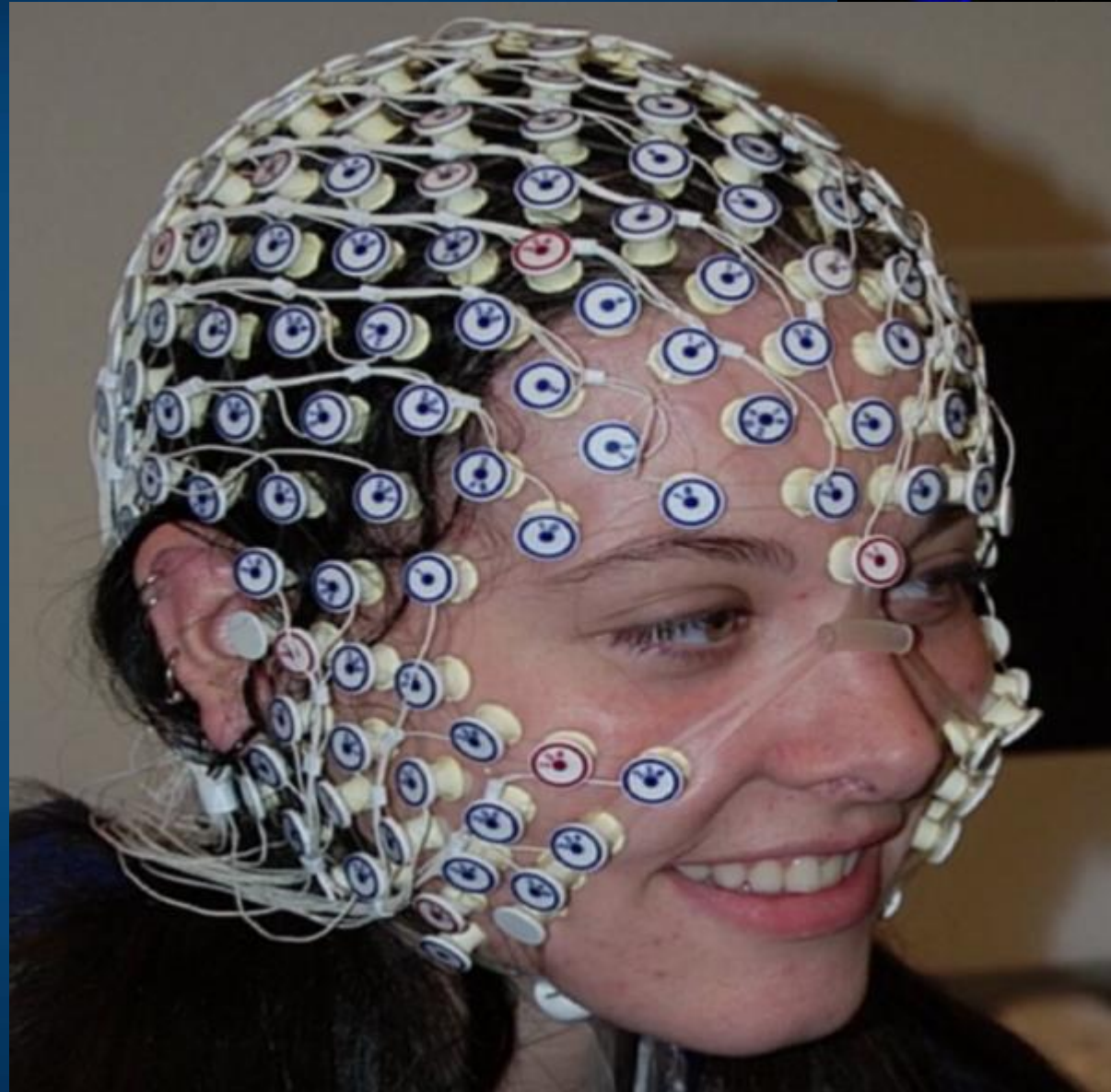

Neurocognitive technologies

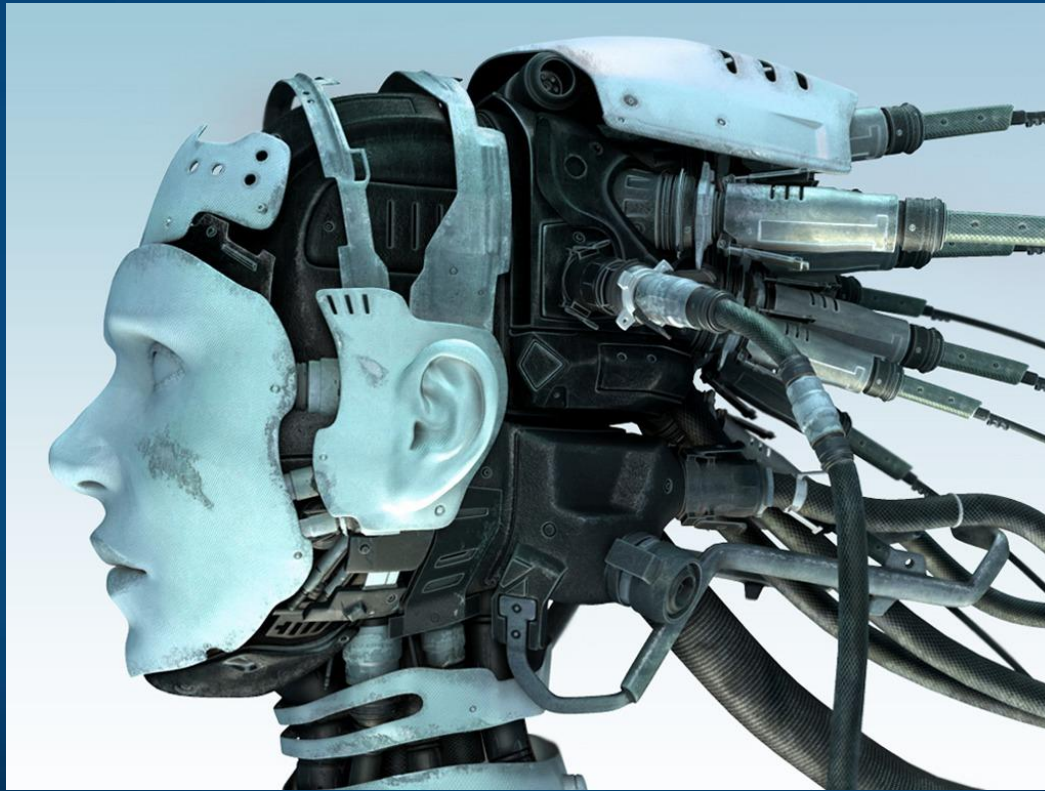

Neuro-relax

Sounds and music may have arousing or relaxing effects.

Melomind:

Simple EEG determines the relaxation level and adaptively creates sounds to increase it.

Neuropriming

Effort, stamina, force in sports requires strong activation of muscles by motor cortex. Synchronize your effort with direct current cortex stimulation.

MEASURABLE GAINS

See how Olympians, professional athletes, and top teams have unlocked double-digit performance gains.

[See the Case Studies](#)

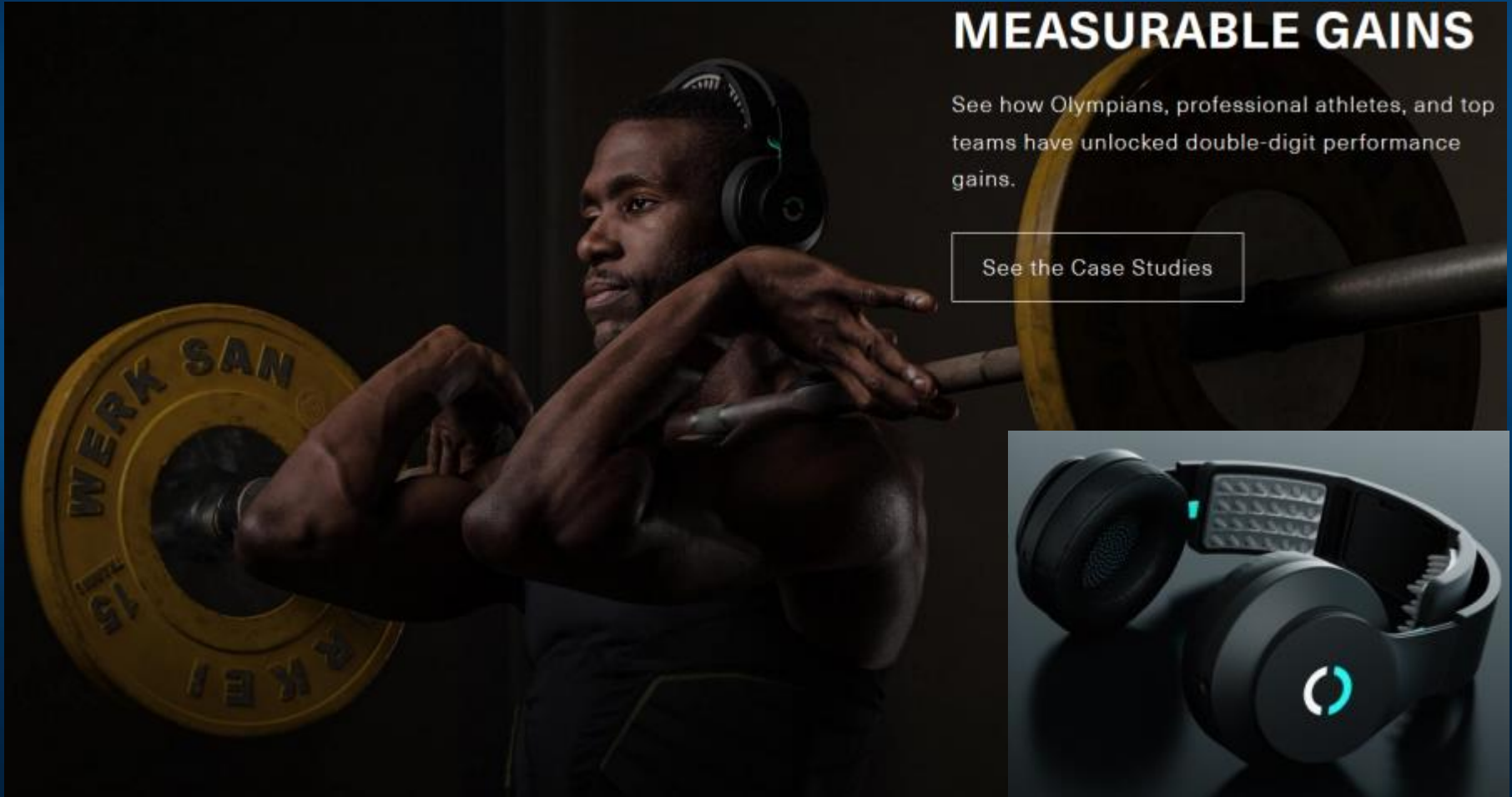

DCS for attention/relaxation

Focusing attention for a long time requires effort: PFC activates brain regions processing signals from various modalities. External stimulation using alternating currents (tDCS) or magnetic pulses (rTMS) gives good results in case of games, pilots, combat soldiers. Control yourself with a smartphone! **Thync** arouses the brain before action and relaxes after.



BCBI for learning

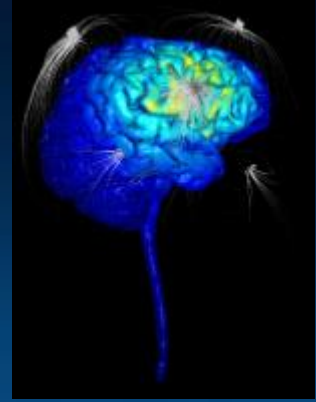

Your brain knows better what is interesting than you do!
Information relevance inferred directly from brain signals to model search intent.

Eugster et al. (2016). Natural brain-information interfaces:
Recommending information by relevance inferred from human brain signals.

Externally induced frontoparietal synchronization modulates network dynamics and enhances working memory performance (Violante et al. 2017).

Neuroimaging based assessment strategy may provide an objective means of evaluating learning outcomes in the application of **Universal Design for Learning (UDL)**, an educational framework created to guide the development of flexible learning environments that adapt to individual learning differences.

Teaching skills by stimulating cortex: microstimulation too low to evoke muscle activation, applied in premotor cortex, instructed specific actions.

- Mazurek & Schieber (2017). Injecting Instructions into Premotor Cortex. *Neuron*, 96(6), 1282–1289.e4.

Military applications

Engagement Skills Trainer (EST) procedures are used by USA army.

Intific Neuro-EST uses EEG analysis and multi-channel transcranial simulation (HD-DCS) to pre-activate the brain of the novice in areas where the expert brain is active.

Real-life transfer learning ...

HD-tDCS may have 100 channels, neurolace and nanowires much more.



Targeted Neuroplasticity Training

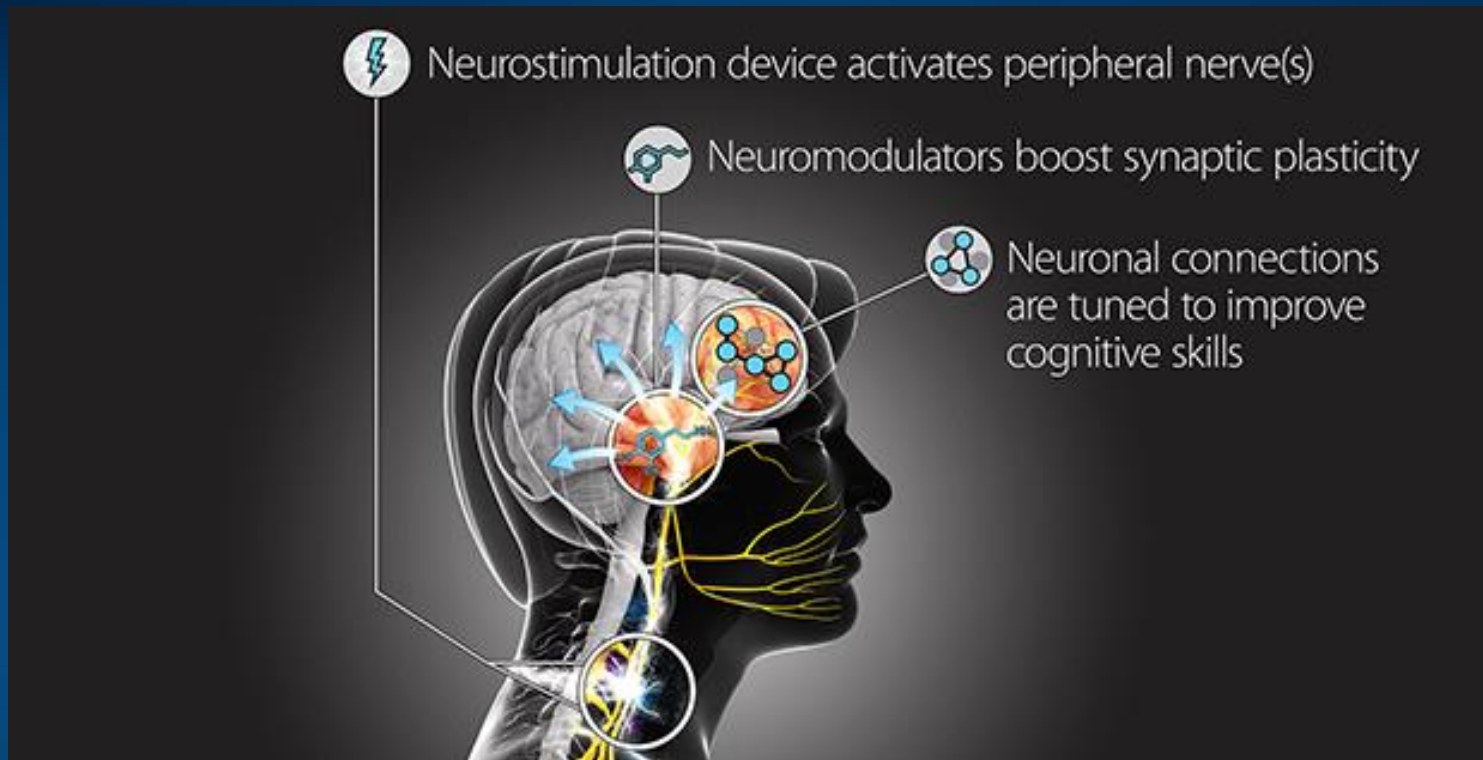

DARPA (2017): Enhance learning of a wide range of cognitive skills, with a goal of reducing the cost and duration of the Defense Department's extensive training regimen, while improving outcomes. TNT could accelerate learning and reduce the time needed to train foreign language specialists, intelligence analysts, cryptographers, and others.

Conclusions

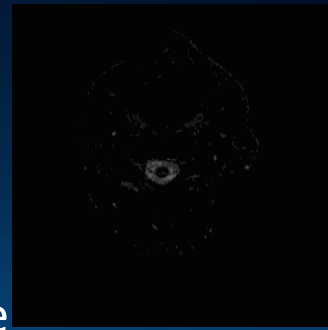

- „Optimization” of brain processes should be possible, but first we need to find good methods for discovering brain fingerprints of cognitive activity, mapping between brain and mental states – our main goal.
- Brain reading, understanding neurodynamics and neurocognitive phenomics, plus stimulation are the key to BCBI for voluntary self-regulation of brain functions, and numerous therapeutic applications.
- Roadmap: Brain neuroimaging \Leftrightarrow models of brain processes \Leftrightarrow links with mental models \Leftrightarrow closed loop BCBI for conscious control/brain optimization
- Neuromorphic hardware with complexity beyond the human brain is coming (ex. IBM Synapse project) and will enable construction of new brain models, deeper understanding of brain functions, and practical applications.
- Neurolace from Neuralink, DARPA project to put million electrodes in human brain and many other developments will integrate brains with artificial systems and change the BCBI game.

With new global AI initiatives anything is possible!

Soul or brain: what makes us human?
Interdisciplinary Workshop with theologians,
Toruń 19-21.10.2016



Monthly international developmental seminars (2017): Infants, learning, and cognitive development

Disorders of consciousness 17-21.09.2017

Autism: science, therapies 23.05.2017



Thank you for
synchronization
of your neurons

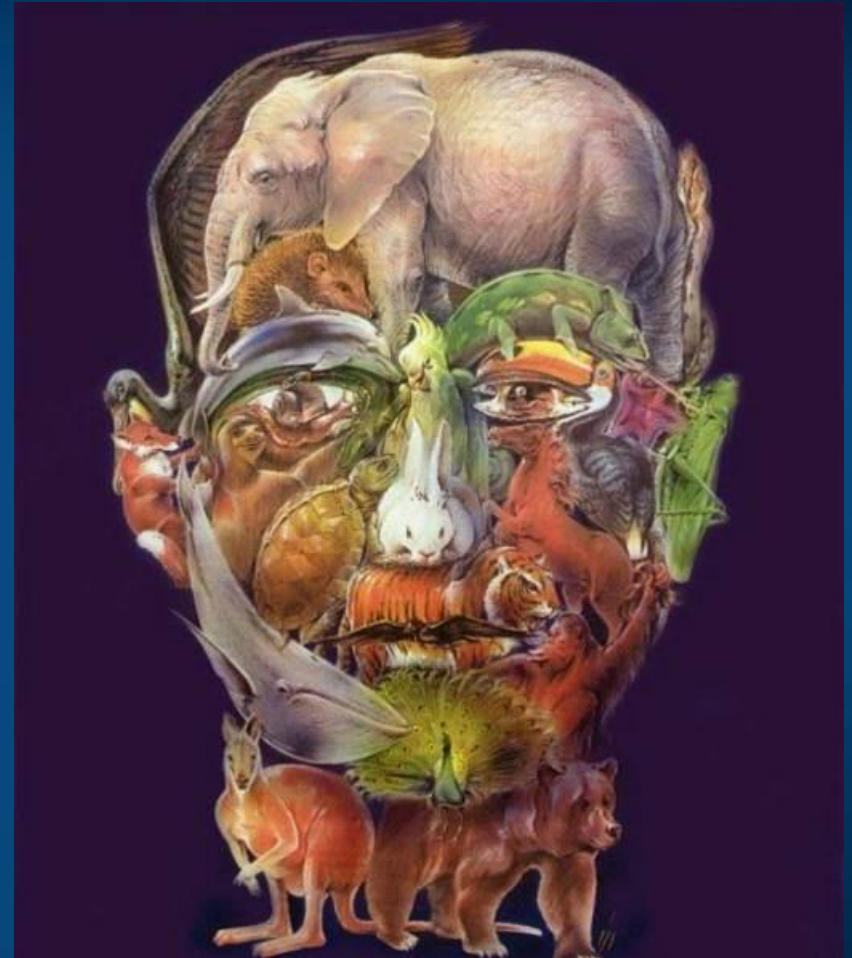
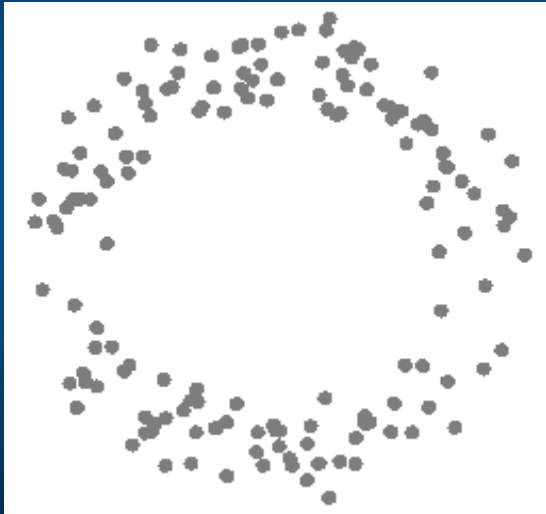

Google: W. Duch
=> talks, papers, lectures, Flipboard ...

Brain control paradigm

EU FET Flagship Projects:

Brain and Mind. But Human Brain Project won ... it was going to build something like **The Virtual Brain**, that has been developed by 11 labs.

Now we have submitted Sapiens 5.0 to the next EU Flagship: Human-AI collaboration for good (<http://www.sapiens5.net/>).

Brain network recovery group – Brain NRG.

This group of 17 scientists spanned the domains of computational, cognitive and clinical neuroscience, but shared a focus on understanding brain network dynamics and how it relates to recovery of function.

<http://www.brainnrg.org/index.php?section=735>